

Terrace 40 3913
Art. Nr. 4018700
1/5

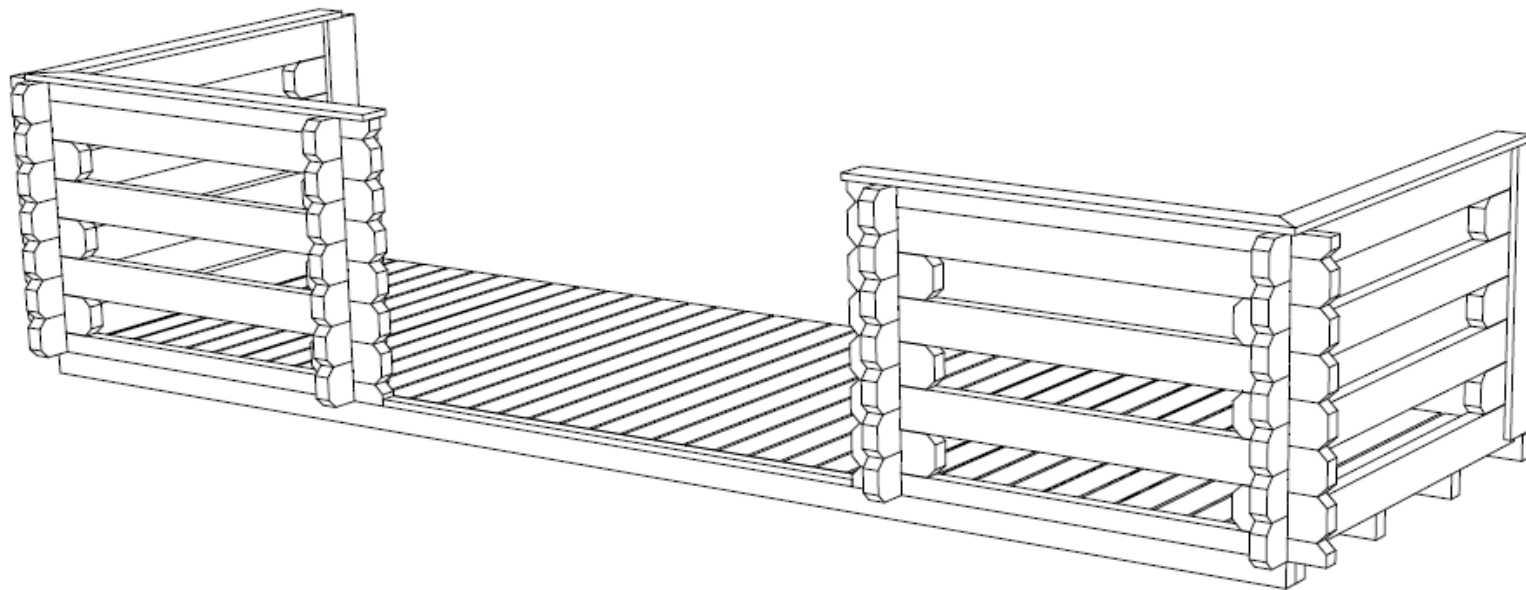

Art.Nr. 4018700

Groundplan - Grundplan - Plan de masse - Planimetria - Plattegrond
- Põhiplaan

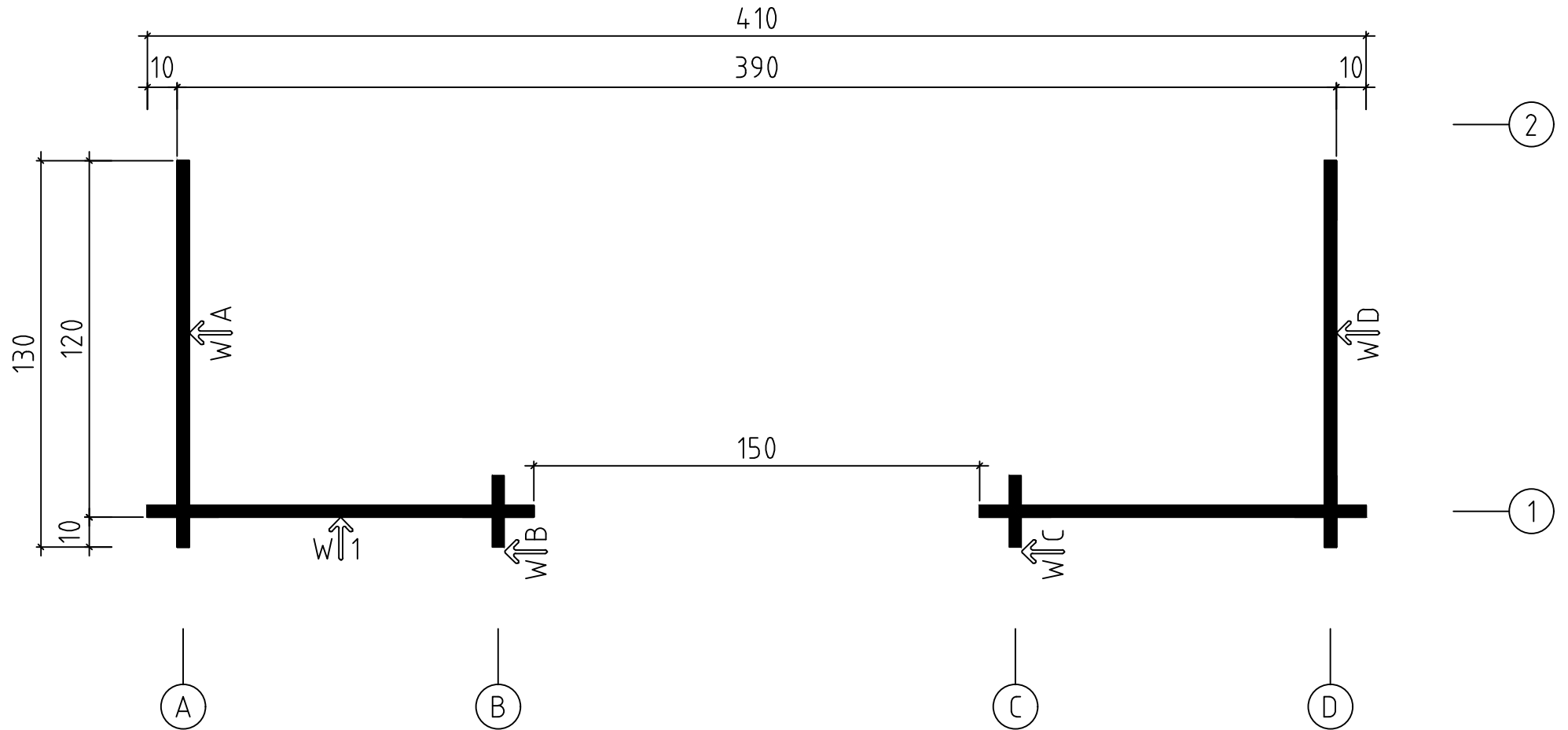

19.04.2018

2/5

Art.Nr. 4018700

Foundation - Fundament - Fondazione -
Fondamenta - Fundering - Immutatud alusraam

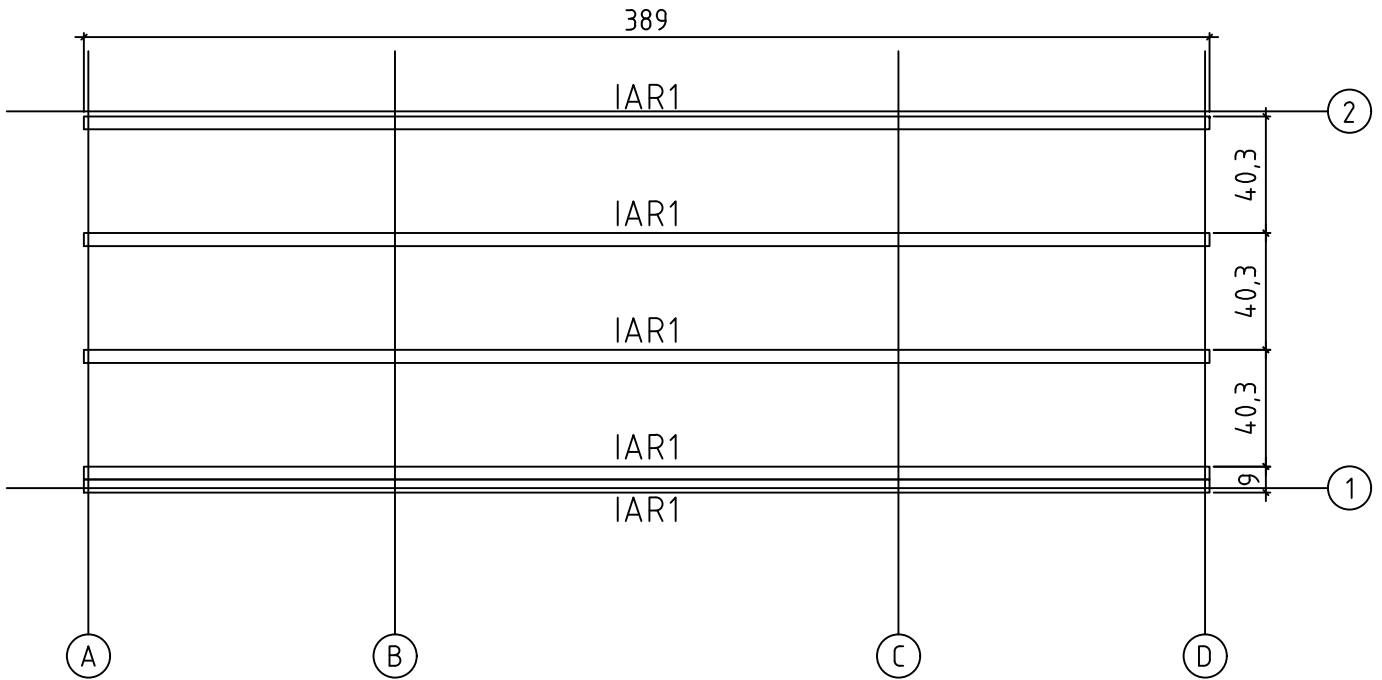



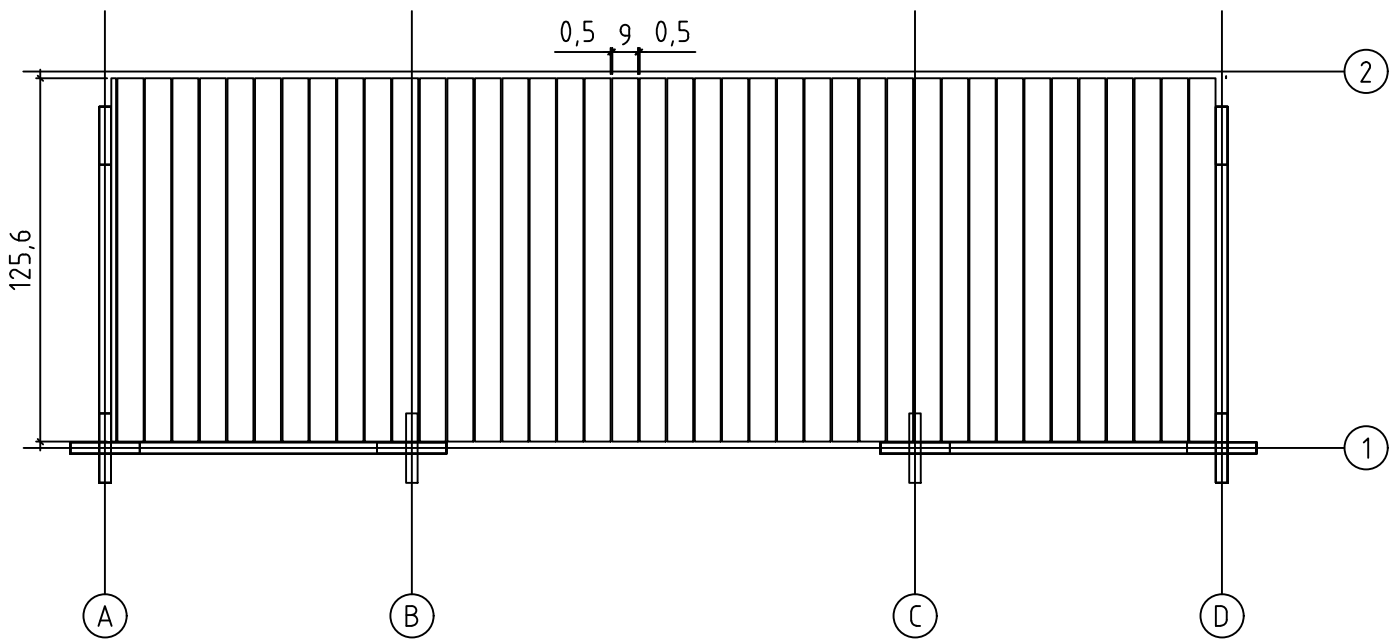



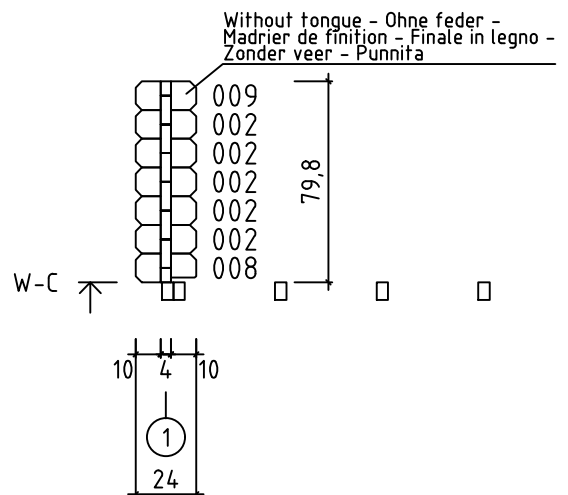
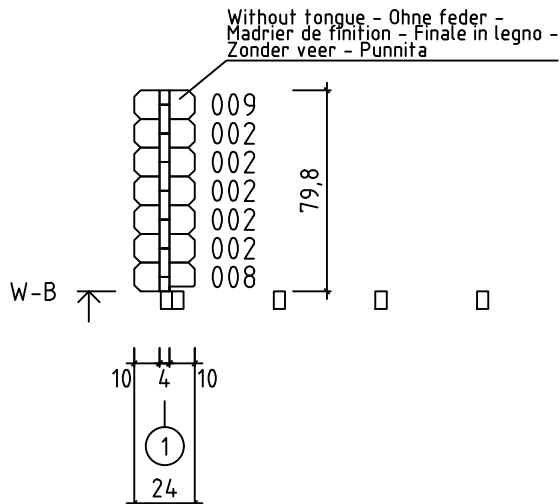
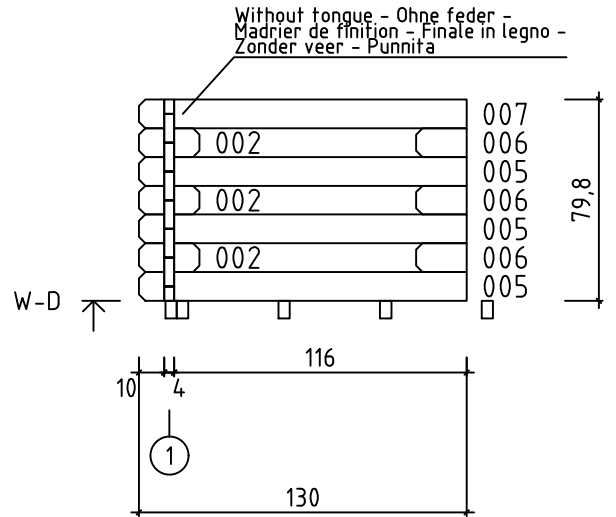
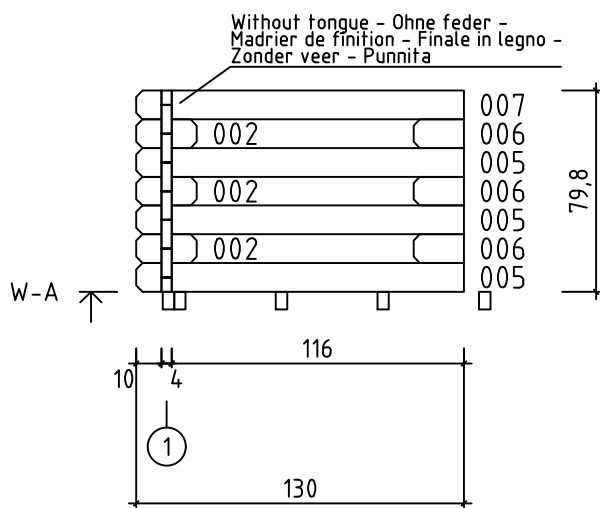
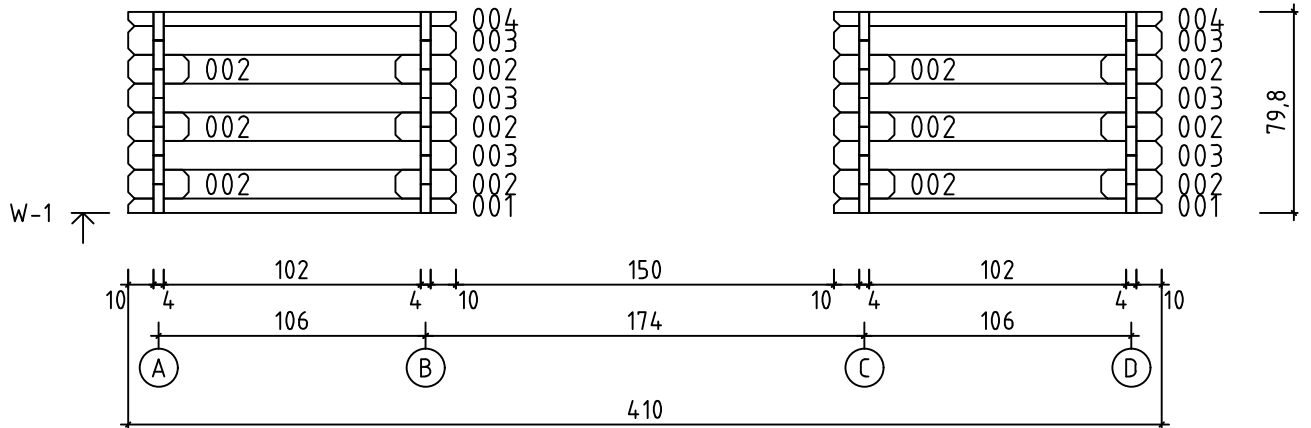

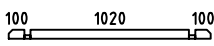

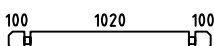
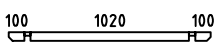
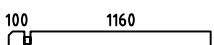

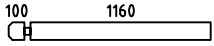



Terrace boards - Terrassenbretter - Plancher de terrasse -
Piattaforme terrazzo - Terrasvloer - Terrassilaudis

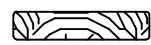

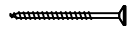
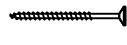
Art.Nr. 4018700

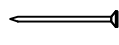

Pos	19.04.2018 Piece list - Stückliste - Liste des pièces - Elementi - Stuklijst - Tükítabel Art.Nr. 4018700 5/5	Q	P (mm)	L (mm)
001		2	40x57	1300
002	100100 	28	40x114	240
003		6	40x114	1300
004		2	40x57	1300
005		6	40x114	1300
006		6	40x114	200
007		2	40x114	1300
008	100100 	2	40x114	240
009	100100 	2	40x114	240
IAR1	Foundation - Fundament - Fondation - Fondamenta - Fundering - Immutatud alusraam 	5	45x70	3890
	Terrace boards - Terrassenbretter - Plancher de terrasse - Piattaforme terrazzo - Terrasvloer - Terrassilaud 	41	90x19	1256
	Terrace edge board - Terrassenbrett, eingang - Lame de seuil d'entree de terrasse - Terrazzo uso abitacolo - Terrasvloer dorpel - Terrassi servaliist 	1	19x40	1498
	Guard-rail for terrace - Terrassengeländer - Main courante de terrasse - Guardrail per terrazzo - Terras leuning - Terrassi äärelaud 	4	18x90	1223
	Terrace joint boards - Verbindungsbrett - Profil de jonction pour fixer la terrasse au mur - Assi del terrazzo che compongono il pavimento - Terras verbindingsplank - Terrassi ühenduslaud 	4	18x120	779
HS12	Screw for terrace joint boards - Schrauben für Verbindungsbrett - Vis de fixation profil de jonction terrasse - Vite per unire delle assi del terrazzo - Schroef voor bevestigen verbindingshout - Kruvi terrassi ühenduseks seinaga 	20	3.5x50	
HS12	Screws for terrace edge board - Schrauben für Terrassenbrett - Vis de fixation de lame de seuil d'entree de terrasse - Vite per unire delle assi del terrazzo - Schroeven voor terrashout - Kruvi terrassi servaliistule 	5	4x40	
HS12	Screw for terrace rear boards - Schrauben für Terrassenrand - Vis de fixation pour main courante de terrasse - Vite per il piano posteriore della terrazzo - Schroef voor terras afsluitplint (achterzijde) - Kruvi terrassi äärelaual 	16	4x40	
HS16	Screw for 1. wall beam - Schraube für 1. Bohlenreihe - Vis de fixations 1ere rangée de madriers avec poutrelles de fondations - Vite fissaggio alle fondamenta - Schroef voor 1 wandbalk - Kruvi poollauale 	4	5x90	
HS16	Screw for foundation - Schrauben zur Befestigung Fundament - Vis de fixations des poutrelles de fondations - Viti x fondamenta - Schroef voor fundering - Kruvi alusraamile 	2	5x90	
HS22	Screw for 1. wall beam - Schraube für 1. Bohlenreihe - Vis de fixations 1ere rangée de madriers avec poutrelles de fondations - Vite fissaggio alle fondamenta - Schroef voor 1 wandbalk - Kruvi poollauale 	4	6x150	
NF3	Zn nail for terrace - Zn Nägel für Terrassenbretter - Pointe pour plancher de terrasse - Chiodo zincato per terrazzo - Spijker (nagel) voor terrasvloer - Nael terrassilauale 	328	2.1x50	