

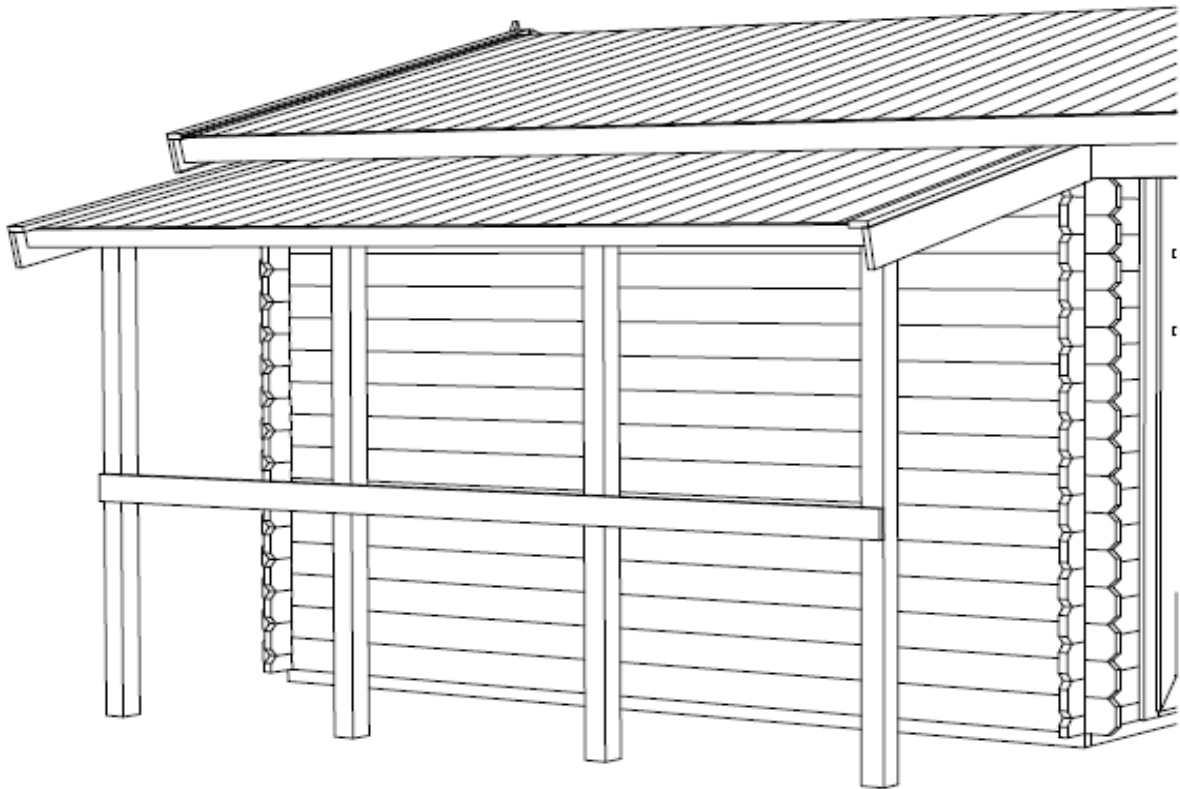

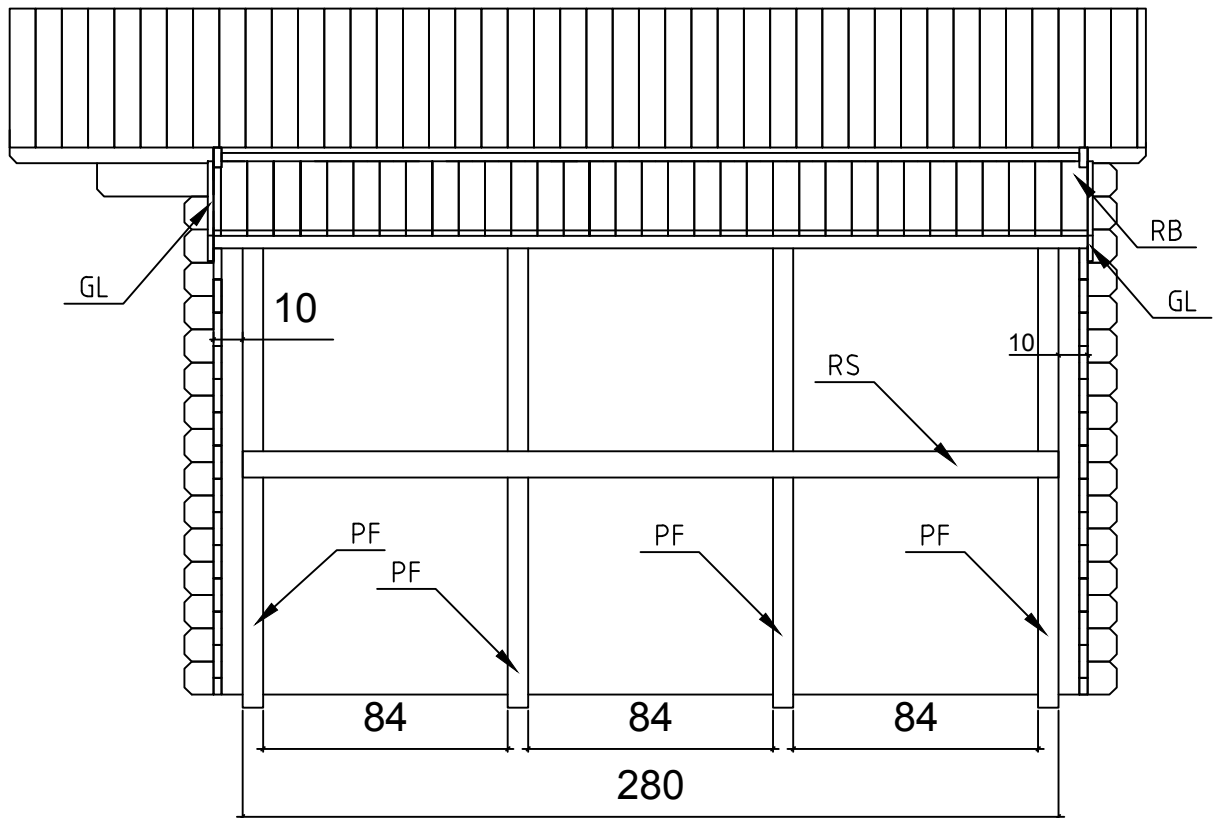

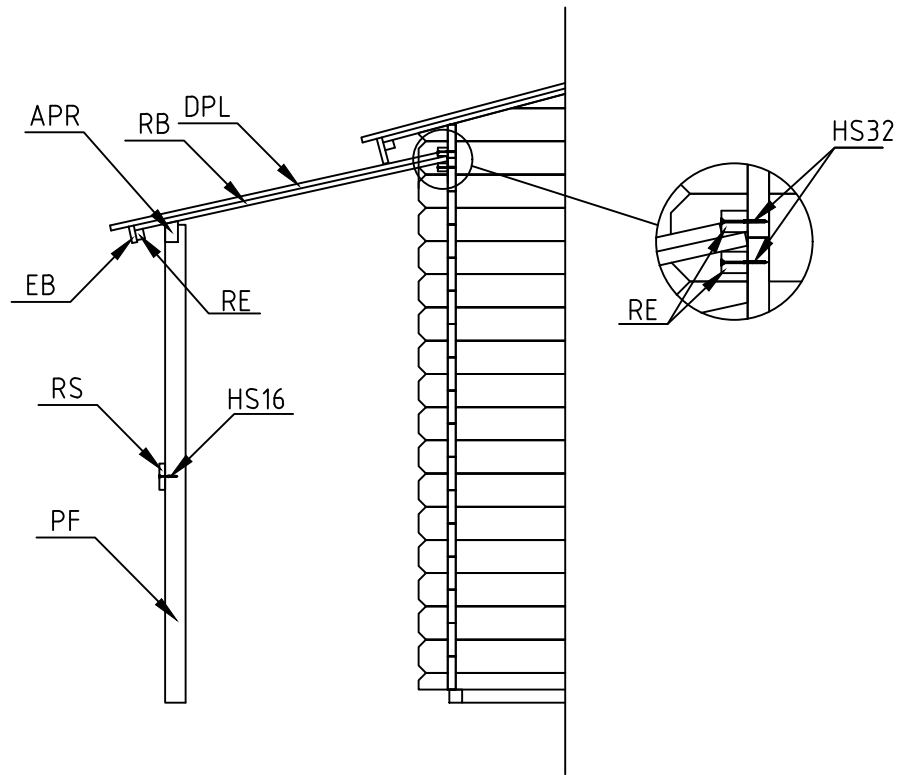

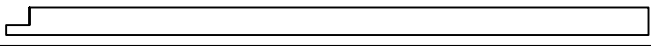





CYPRUS 30 EX
ART.NR. 285200
1/3

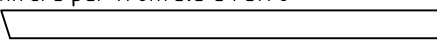
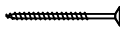

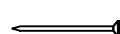

Pos	05.09.2019 Piece list - Stückliste - Liste des pièces - Elementi - Stuklijst - Tükitabel Art. Nr. 285200 3/3	Q	P (mm)	L (mm)
PF	Post - Pfosten - Poteau - Piede registrabile - Stijl - Post 	4	70x70	1640
RS	Railing strip - Begrenzungsleiste - Rembarde - Sbarra - Afscheidingslijst - Piirdelaud 	1	18x90	2800
APR	Roof beam - Dachpfetten - Panne de toit - Perlina del tetto - Gordingen / dakbalk - Pärlinid 	1	44x73	3000
RB	Roof boards - Dachbretter - Voliges - Perlina per tetto - Dakhout - Katuselaud 	34	18x90	1100
RE	Roof edge reinforcement - Dachrandverstärkung - Corniere de renfort de bord de toit - Rinforzo x tetto - Dakrand versterking - Räästatugevdus 	3	28x34	3000*
EB	Fascia board - Traufbrett - Bandeau de toit - Finitura lati tetto - Gevellijst - Räästalaud 	1	18x58	3000
DPL	Roofing felt fillet - Dachpappenleiste - Baguette de fixation du feutre bitumeux - Asse per fissaggio guaina bituminosa - Afdekljst asfaltpapier - Katusepapiilist 	2	18x58	1150
GL	Gable moulding - Giebelleiste - Planche de rive - Finitura per frontale e retro del tetto - Gevellijst - Viilulaud 	2	18x90	1150*
HS16	Screw for gable moulding - Schrauben für giebelleiste - Vis pour fixation planche de rive - Vite per fissare finiture davanti e dietro del tetto - Schroef voor gevellijst - Kruvi viilulauale 	8	3.5x50	
HS26	Screw for fascia boards - Schrauben für traufbretter - Vis pour fixation bandeau de toit - Viti x striscia del tetto - Schroef voor gevellijst - Kruvi räästalauale 	7	4x40	
HS26	Screw for roof edge reinforcement - Schrauben für dachrandverstärkung - Vis pour fixation corniere renfort de bord de toit - Viti x rinforzo bordo tetto - Schroef voor dakrand versterking - Kruvi räästatugevdusele 	7	4x40	
HS16	Screw for roof beams - Schrauben für dachbalken - Vis pour fixation pannes de toit - Viti per perline del tetto - Schroef voor gordingen / dakbalken - Kruvi pärlinitele 	8	3.5x50	
NFD	Zn nail for roofing felt fillet - Zn nägel für dachpappenleiste - Pointe pour baguette de fixation feutre bitumeux - Chiodi x carta bituminosa x tetto - Spijker(nagel) voor asfaltpapier afdekljst - Papiilistunael 	8	2x40	
NF2	Zn nail for roof - Zn nägel für dachbretter - Pointe pour fixation voliges de toit - Chiodi x perline tetto - Spijker(nagel) voor dakhout - Nael katuselauale 	70	2.1x50	
HS32	Screw for roof edge reinforcement - Schrauben für dachrandverstärkung - Vis pour fixation corniere renfort de bord de toit - Viti x rinforzo bordo tetto - Schroef voor dakrand versterking - Kruvi räästatugevdusele 	12	4x60	
HS16	Screw for covering moulding - Schrauben für deckungsprofil - Vis de fixation profils horizontaux haut inférieur et extérieur d'encadrement de porte - Vite per cornice di copertura - Schroef voor afdekprofiel - Kruvi piirdelauale 	8	3.5x50	
*	Cut into length on site (if needed)! - Länge ggf. selbstständig anpassen - Au besoin, coupez sur place pour raccourcir - Aggiunstars con taglio la lunghezza in cantiere (se necessario)! - Graag ter plekke op maat maken (als nodig)! - Vajadusel lõigata mõõtu			