

AS Lasita Maja  
Pihva küla  
Risu tee 2  
61407 Tähtvere vald  
Tartumaa, Estonia  
www.lasita.com

*Art. Nr. 447722*

1/3



15.02.2017

Art.Nr. 447722

SUPPORT BEAM FOR GATE FRAME - STUTZBOHLE FÜR TORZARGE - MADRIER DE SUPPORT DU CADRE DE LA PORTE BASCULANTE - ASSE DI SUPPORTO PER IL TELAIO DELLA PORTA

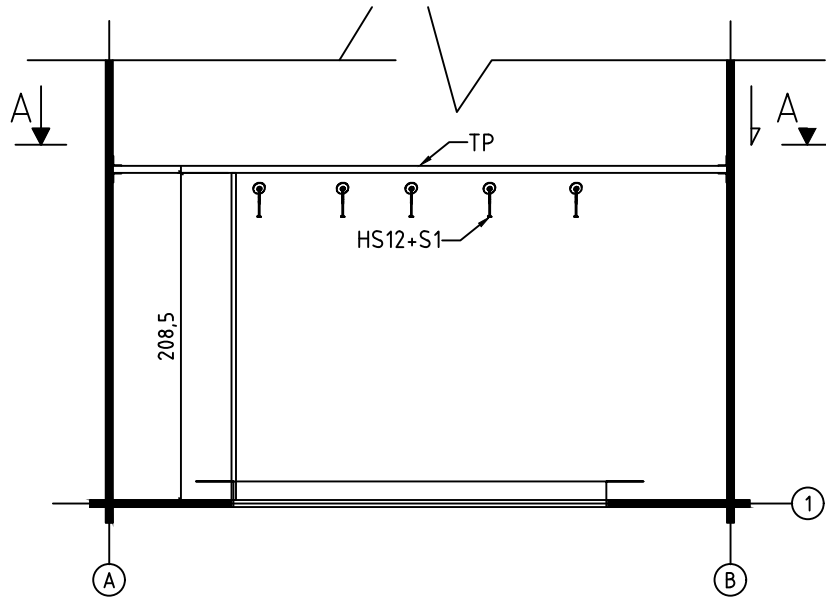

Wall-Wand-Mur-Parete 1

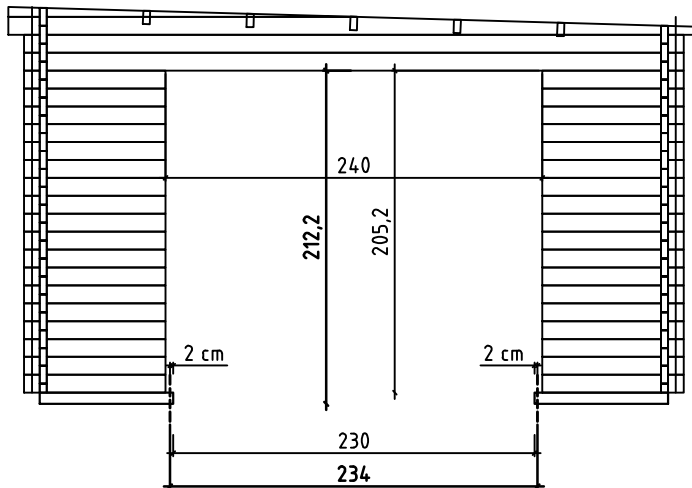
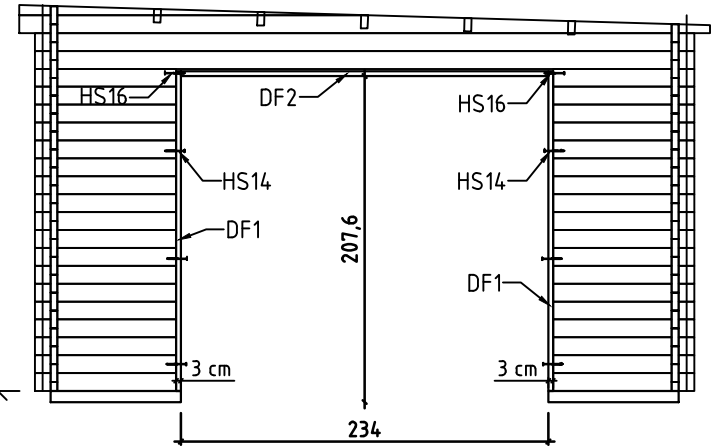





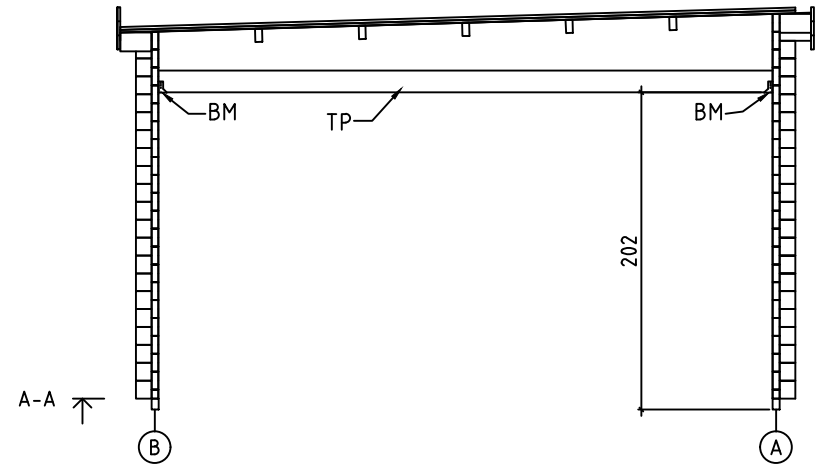



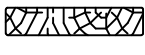
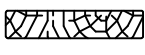

Wall-Wand-Mur-Parete 1

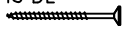
15.02.2017

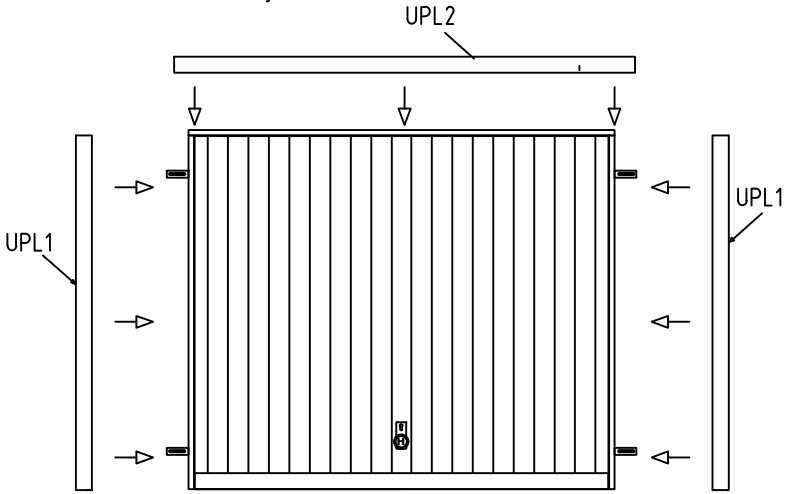

2/3

Pos	15.02.2017	Piece list - Stückliste - Liste des pièces - Elementi Art.Nr. 447722	3/3	Q.	P. (mm)	L. (mm)
DF1		COVERING MOULDING - DECKUNGSPROFIL - PROFILS DE FINITION VERTICAUX A FIXER A L'EXTERIEUR DU CADRE DE LA PORTE - CORNICE DI FINITURA		2	30x46	2036
DF2		COVERING MOULDING - DECKUNGSPROFIL - PROFILS DE FINITION VERTICAUX A FIXER A L'EXTERIEUR DU CADRE DE LA PORTE - CORNICE DI FINITURA		1	30x46	2340
UPL1		COVERING MOULDING - DECKUNGSPROFIL - PROFILS DE FINITION VERTICAUX A FIXER A L'EXTERIEUR DU CADRE DE LA PORTE - CORNICE DI FINITURA		2	18x90	2076
UPL2		COVERING MOULDING - DECKUNGSPROFIL - PROFILS DE FINITION VERTICAUX A FIXER A L'EXTERIEUR DU CADRE DE LA PORTE - CORNICE DI FINITURA		1	18x90	2570
BM		BEAM HOLDER - BALKENHALTER - SUPPORT EN U GALVANISÉ - SUPPORTO DELLA TRAVE		2	45x97	
HS9		SCREW FOR COVERING MOULDING (UPL) - SCHRAUBEN FÜR DECKUNGSPROFIL (UPL) - VIS DE FIXATION PROFILS HORIZONTALS HAUT INTÉRIEUR ET EXTÉRIEUR D'ENCADREMENT DE PORTE (UPL) - VITE PER CORNICE DI COPERTURA (UPL)		18	3.5x50	
HS14		SCREW FOR COVERING MOULDING (DF) - SCHRAUBEN FÜR DECKUNGSPROFIL (DF) - VIS DE FIXATION PROFILS HORIZONTALS HAUT INTÉRIEUR ET EXTÉRIEUR D'ENCADREMENT DE PORTE (DF) - VITE PER CORNICE DI COPERTURA (DF)		6	4.5x80	
HS12		SCREW FOR FIXING GATE FRAME TO SUPPORT BEAM (TB)- SCHRAUBE FÜR MONTAGE TORZARGE MIT STUTZBOHLE (TB) - VIS DE FIXATION POUR MADRIER DE SUPPORT DE CADRE DE LA PORTE BASCULANTE (TB)- VITE PER IL FISSAGGIO DEL CANCELLO (TB)		5	4x40	
HS16		SCREW FOR DOOR JAMB - SCHRAUBE FÜR TÜRRAHMEN - VIS DE FIXATION PARTIE HAUTE AVEC MONTANTS DU CADRE DE PORTE - VITI x FISSAGGIO MONTANTI PORTE		2	5x90	
HS26		SCREW FOR BEAM HOLDER - SCHRAUBEN FÜR BALKENHALTER - VIS DE FIXATION SUPPORT "U" GALVANISÉ - VITE PER TRAVE DI SOSTEGNO		24	5x40	
S1		PLAIN WASHER FOR FIXING GATE FRAME TO SUPPORT BEAM (TB) - UNTERLEGSCHEIBE ZUR FIXIERUNG DES TORRAHMENS AM UNTERSTÜTZENDEN HOLM (TB) - RONDELLE POUR ASSEMBLAGE MADRIER DE SUPPORT DE CADRE DE LA PORTE BASCULANTE (TB) - RONDELLA PIANA PER IL FISSAGGIO DEL TELAIO DELLA PORTA ALLA TRAVE DI SOSTEGNO (TB)		5	D6	
		DOOR-TÜR-PORTE-PORTE Hörmann Berry 2375x2075		1		