

# Malaga 44-A Klassik

Wandaußenmaß: 450 x 330 cm

Bohlenstärke: 44 mm



Malaga 44-A Klassik

Kontrolliert durch:

Achtung: Alle angegebenen Maße sind ca.-Maße!

# Malaga 44-A Klassik



Malaga 44-A Klassik

Kontrolliert durch:

Achtung: Alle angegebenen Maße sind ca.-Maße!

# 3D-Darstellung und Grundriss Korpus für Malaga 44-A Klassik

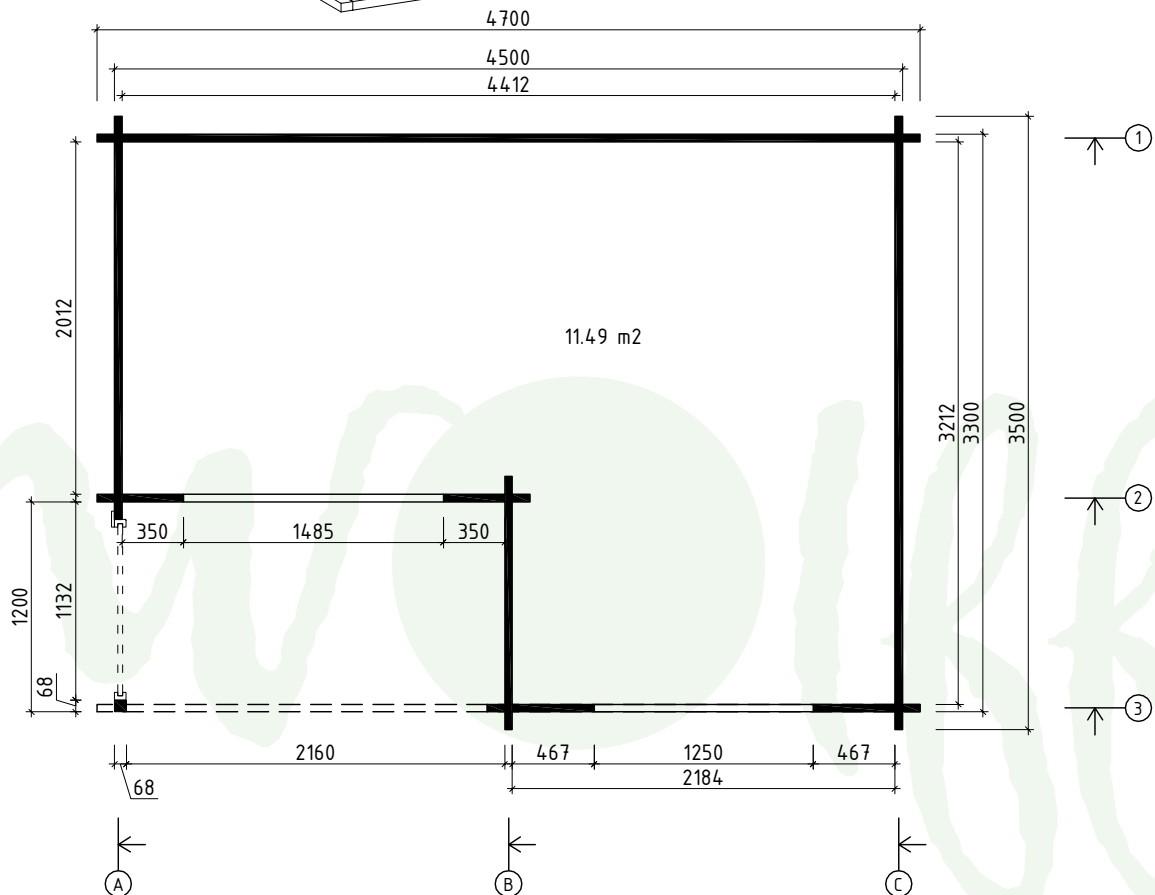
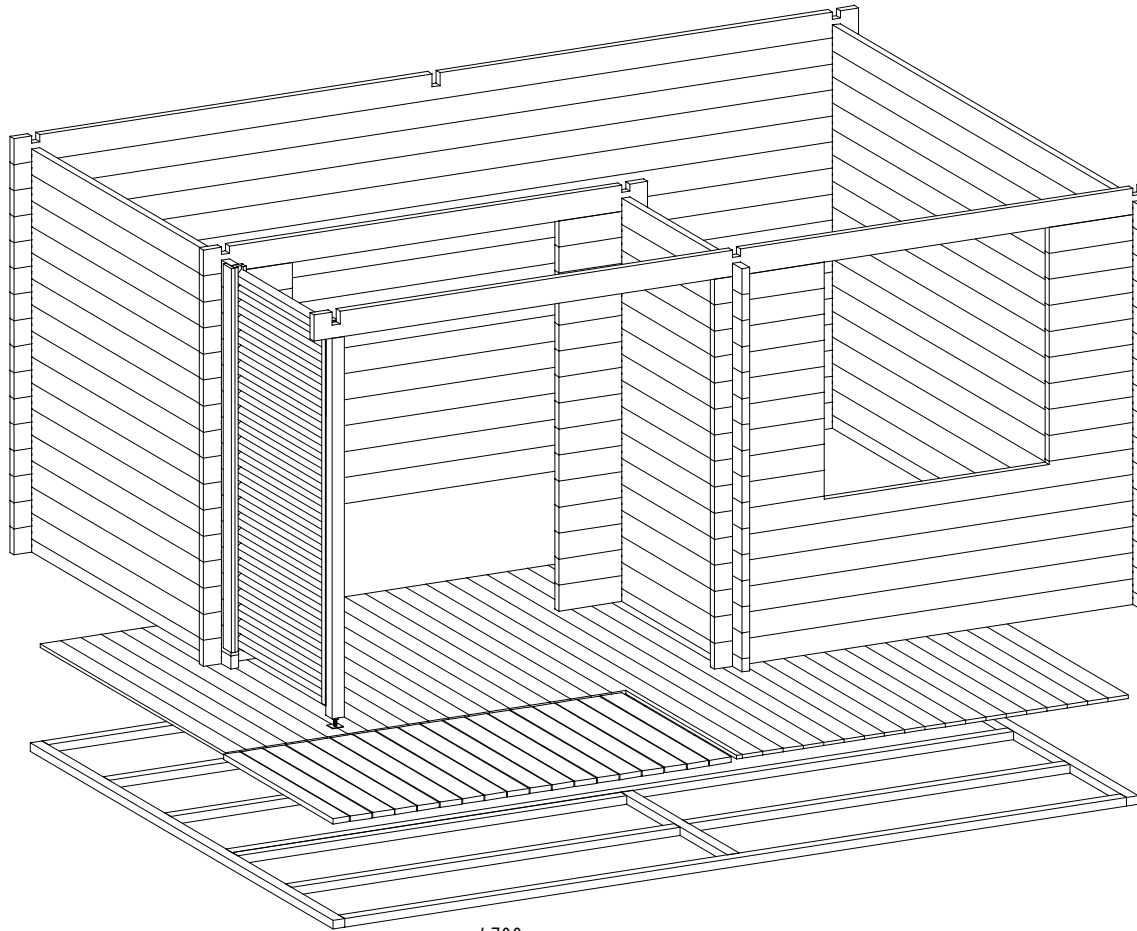

# Lagerholzplan und Fundamentplan Korpus für Malaga 44-A Klassik



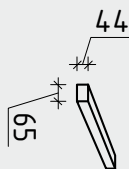
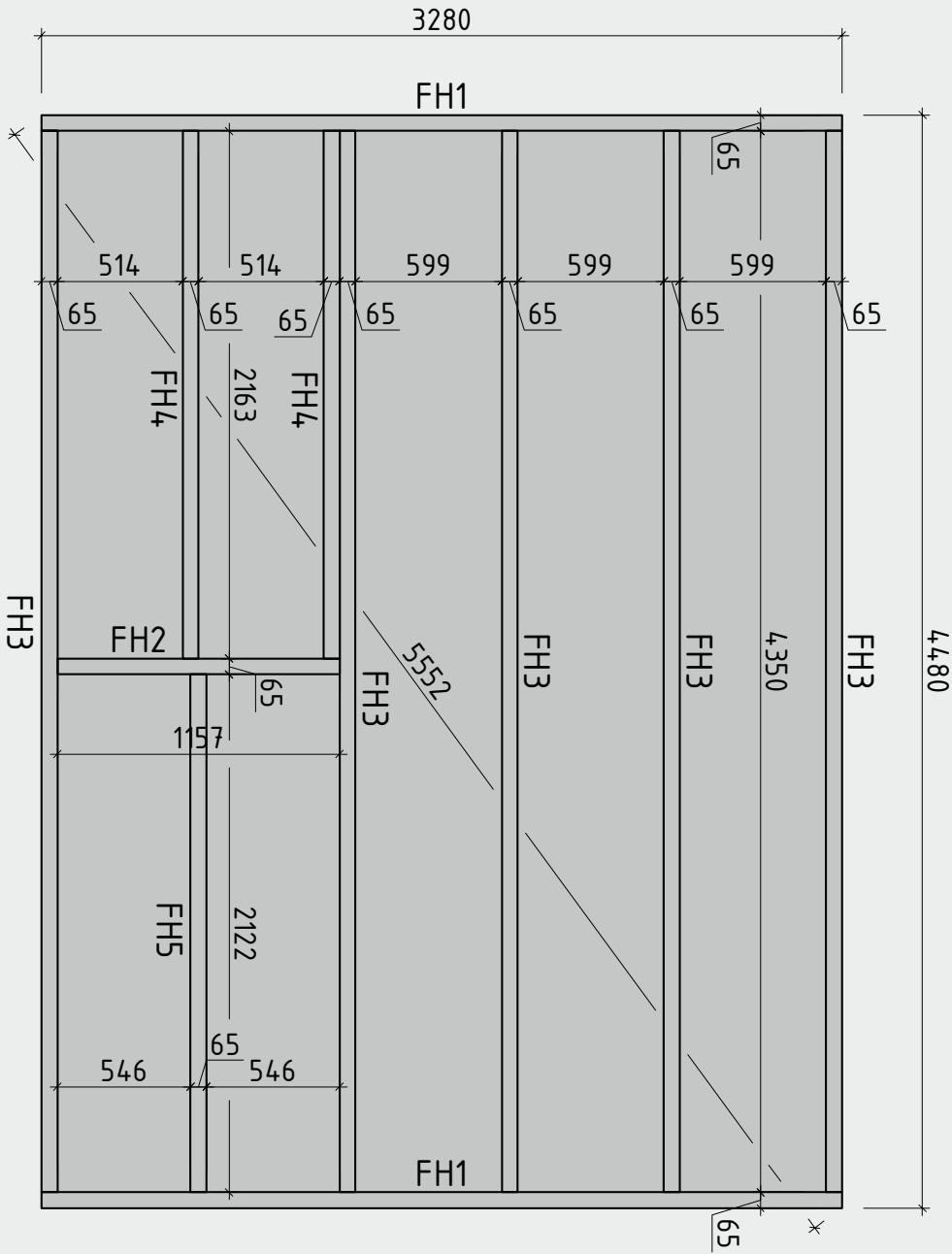







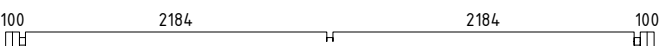
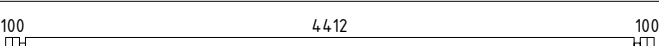

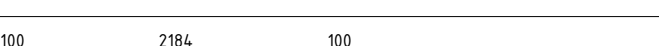
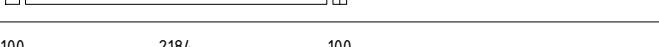
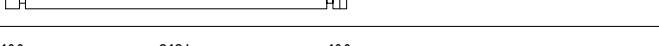

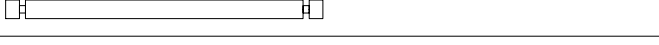
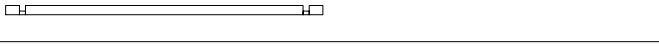



Wir empfehlen als Fundament für Ihr Gartenhaus eine vollflächig, festgegründete gepflasterte oder betonierte Fläche.  
Wahlweise ist auch ein Punkt- oder Streifenfundament möglich.

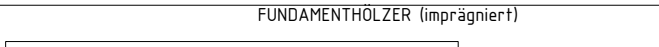





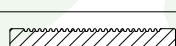







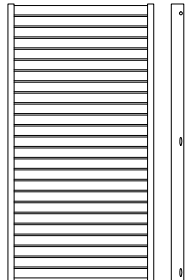



# Teileliste 1

## Korpus für Malaga 44-A Klassik

| Pos   |  | Stck | Profil (mm) | Länge (mm) |
|-------|--|------|-------------|------------|
| 001   |                                     | 1    | 44x135      | 4700       |
| 002   |                                     | 1    | 44x135      | 4700       |
| 003   |                                     | 15   | 44x135      | 4700       |
| 004   |                                     | 15   | 44x135      | 3500       |
| 005   |                                     | 1    | 44x68       | 3500       |
| 006   |                                     | 1    | 44x135      | 2472       |
| 007   |                                     | 5    | 44x135      | 2472       |
| 008   |                                     | 1    | 44x135      | 2472       |
| 009   |                                     | 15   | 44x135      | 2300       |
| 010   |                                     | 1    | 44x68       | 2300       |
| 011   |                                   | 15   | 44x135      | 1444       |
| 012   |                                   | 1    | 44x68       | 1444       |
| 013   |                                   | 9    | 44x135      | 611        |
| 014   |                                   | 9    | 44x135      | 611        |
| 015   |                                   | 30   | 44x135      | 493        |
| FH3   | FUNDAMENTHÖLZER (imprägniert)<br> | 5    | 65x44       | 4350       |
| FH1   | FUNDAMENTHÖLZER (imprägniert)<br> | 2    | 65x44       | 3280       |
| FH4   | FUNDAMENTHÖLZER (imprägniert)<br> | 2    | 65x44       | 2163       |
| FH5   | FUNDAMENTHÖLZER (imprägniert)<br> | 1    | 65x44       | 2122       |
| FH2   | FUNDAMENTHÖLZER (imprägniert)<br> | 1    | 65x44       | 1157       |
|       | FUSSBODENBRETTER                 | 20+1 | 113x18      | 3205       |
|       | FUSSBODENBRETTER                 | 19   | 113x18      | 2005       |
|       | TERRASSENBRETTER (imprägniert)   | 18+1 | 120x28      | 1190       |
|       | FUSSBODENLEISTE                   | ✓    | 18x40       | 16,0 lfm   |
| SP1-1 | STÜTZPFOSTEN 68x68               | ✓    | 68x68       | 2095       |

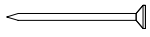
# Teileliste 2

## Korpus für Malaga 44-A Klassik

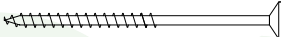
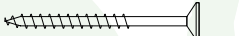
| Pos  |  |  | Stck. | Profil (mm) | Länge (mm) |
|------|--|--|-------|-------------|------------|
|      | GITTERWAND ELEMENT                                       |    | 1     | 105x1994    |            |
| SH   | Schlaghölzer   |     | 3     |             |            |
| SS02 | Schlossschrauben M8x70 Mutter U-Scheibe (für Gitterwand) |    | 3     | M8          |            |
| VP1  | Verstellbare Pfostenstütze M10                           |     | 1     | M10         |            |
| KL1  | Gewindestange M8   |     | 3     | M8          | 2000       |
| KL2  | Gewindestange M8   |     | ✓ 1   | M8          | 460        |
| KL3  | Gewindestange M8   |   | ✓ 2   | M8          | 325        |
| KL4  | Gewindestange M8   |   | ✓ 1   | M8          | 430        |
|      | Mutter M8 U-Scheibe Ø25                                  |  | 8     | M8          |            |
|      | Befestigungsmutter M8                                    |   | 3     | M8          |            |
| NG1  | NÄGEL 2.5x50 Dachbretter Fussbodenbretter                |  | 390   |             |            |
| NG2  | NÄGEL 2.5x60 Terrassenbretter                            |  | 108   |             |            |
| SR01 | SCHRAUBEN 3.0x30 Fussbodenleisten                        |   | 30    |             |            |
| SR03 | SCHRAUBEN 3.5x45 Gitterwand                              |  | 6     |             |            |
| SR11 | SCHRAUBEN 5.0x100 Fundamenthölzer                        |  | 28    |             |            |
| SR10 | SCHRAUBEN 5.0x70 Gitterwand                              |  | 4     |             |            |
|      |  |  |       |             |            |
|      |  |  |       |             |            |
|      |  |  |       |             |            |
|      |  |  |       |             |            |
|      |  |  |       |             |            |
|      |  |  |       |             |            |
|      |  |  |       |             |            |
|      |  |  |       |             |            |
|      |  |  |       |             |            |
|      | ✓ - bitte selber anpassen (falls nötig)!                 |  |       |             |            |

# Teileliste 3

## Korpus für Malaga 44-A Klassik

### Montageanleitung für Gitterwand

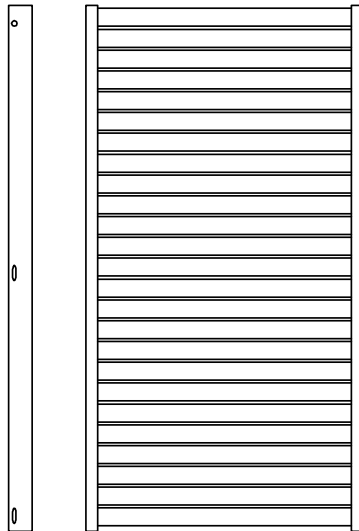

Schrauben 3.5\*45mm

6 Stck.



Schrauben 5x70mm

4 Stck.

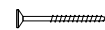

Schlossschrauben M8x70  
Mutter U-Scheibe

3 Stck.

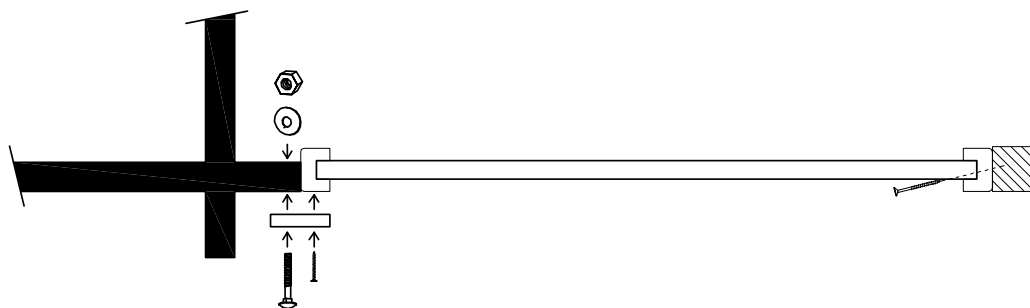
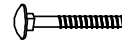

Spiegelverkehrt

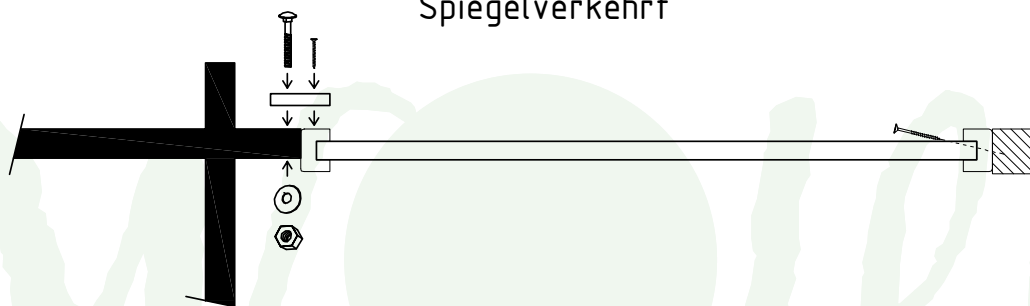

# Wandplan 1 und 2 Korpus für Malaga 44-A Klassik

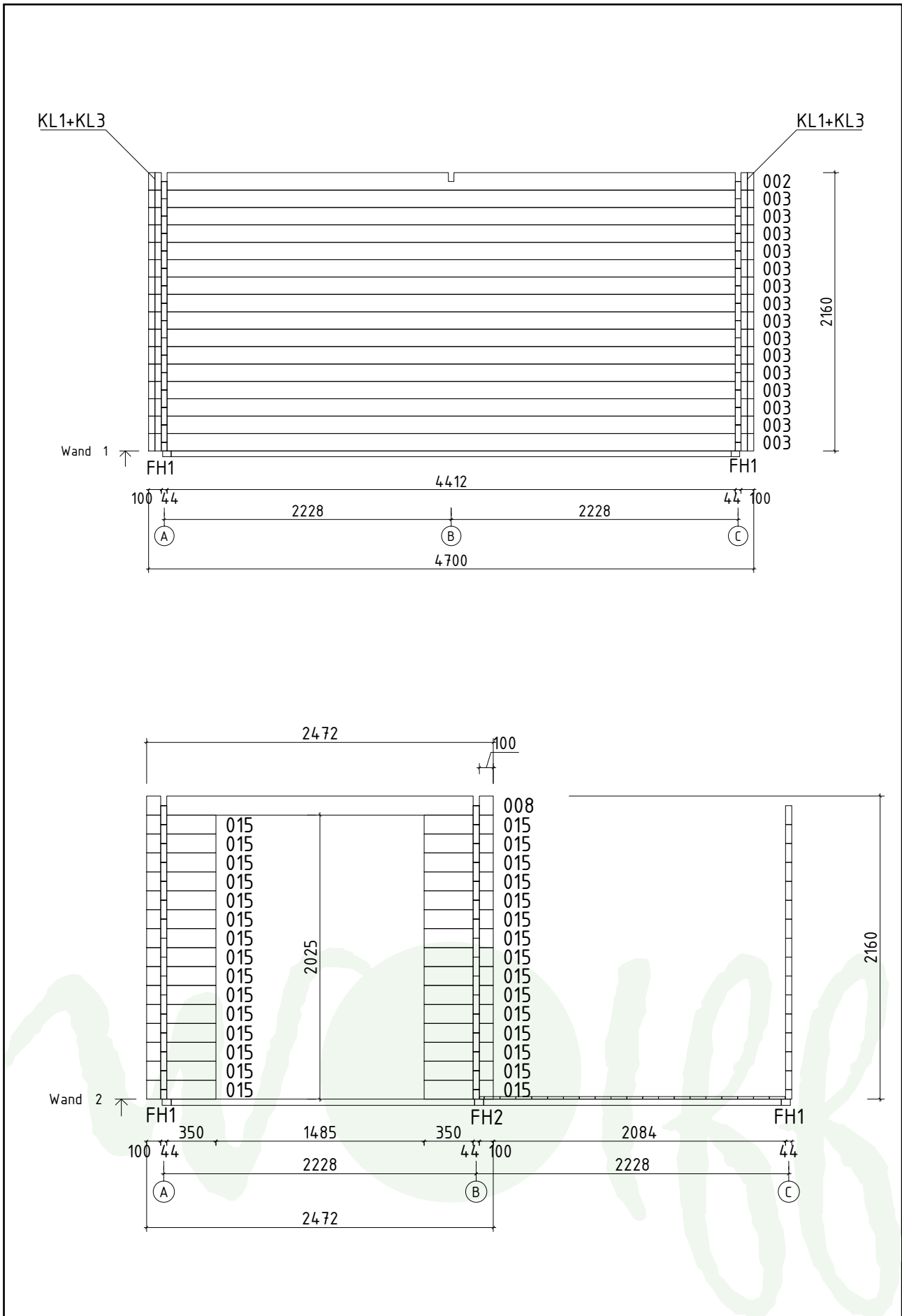



# Wandplan 3

## Korpus für Malaga 44-A Klassik

### Malaga 44-A Klassik

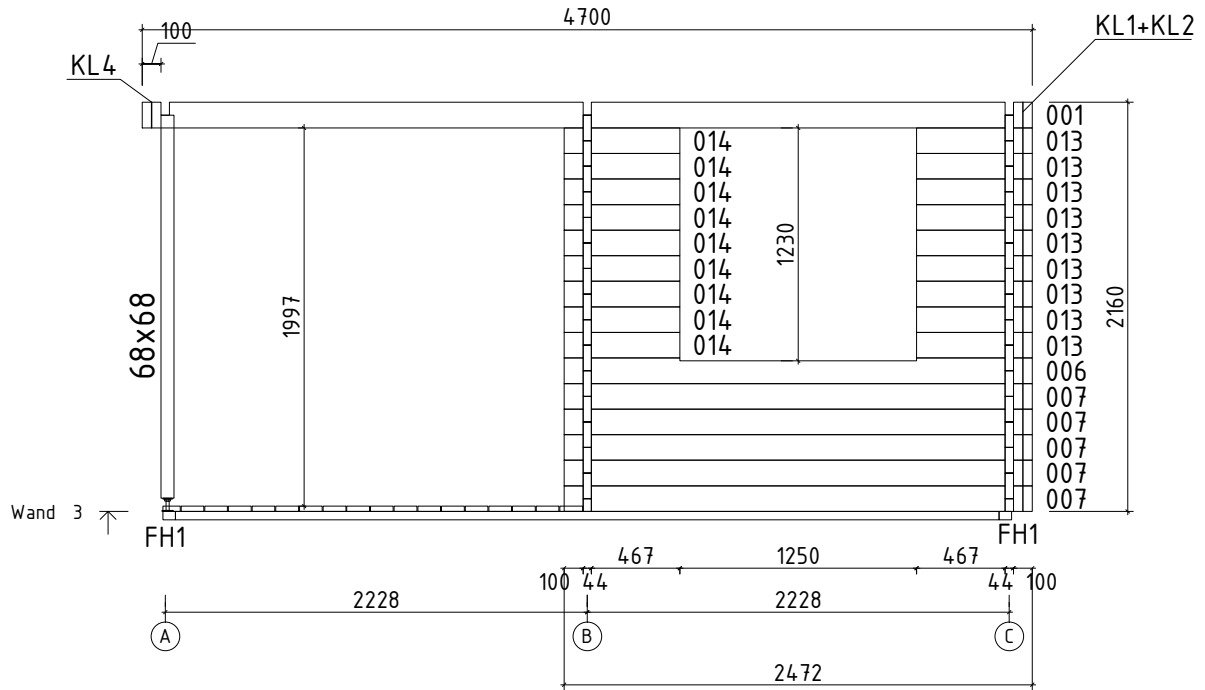

# Wandplan A und B Korpus für Malaga 44-A Klassik

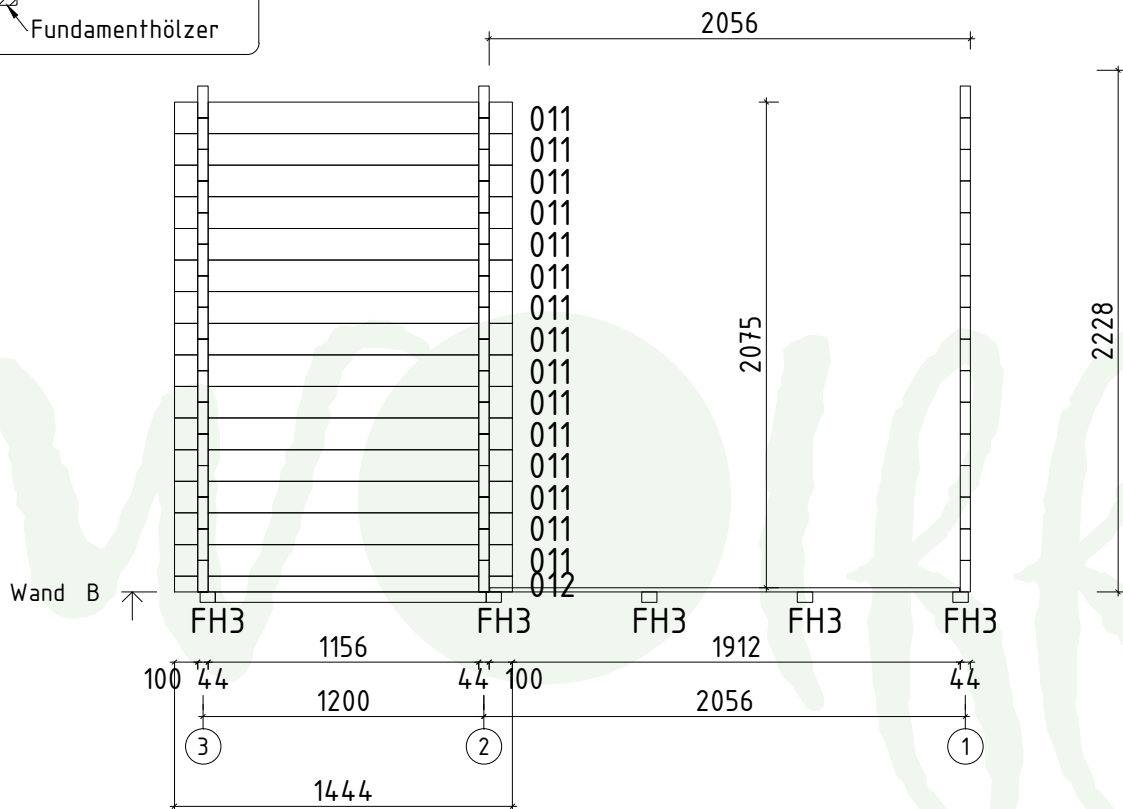
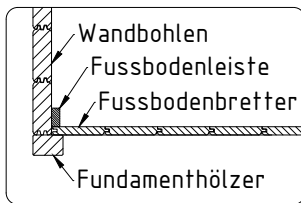
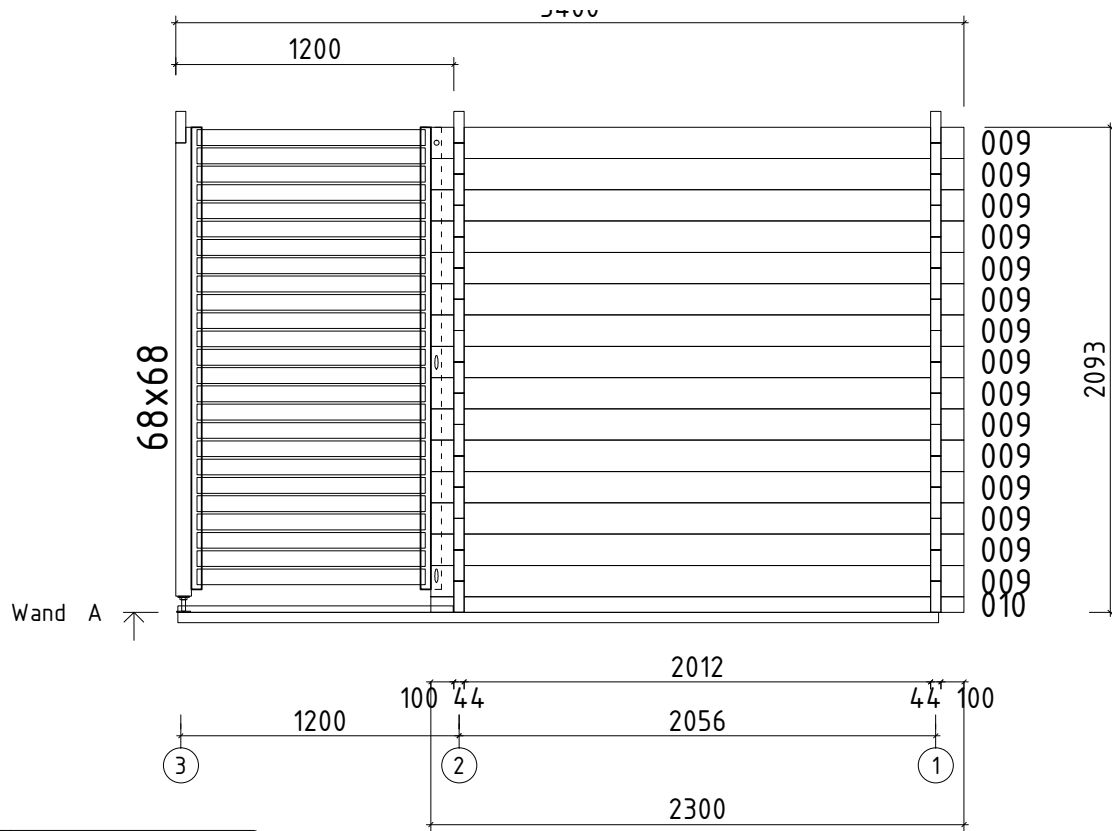

# Wandplan C

## Korpus für Malaga 44-A Klassik

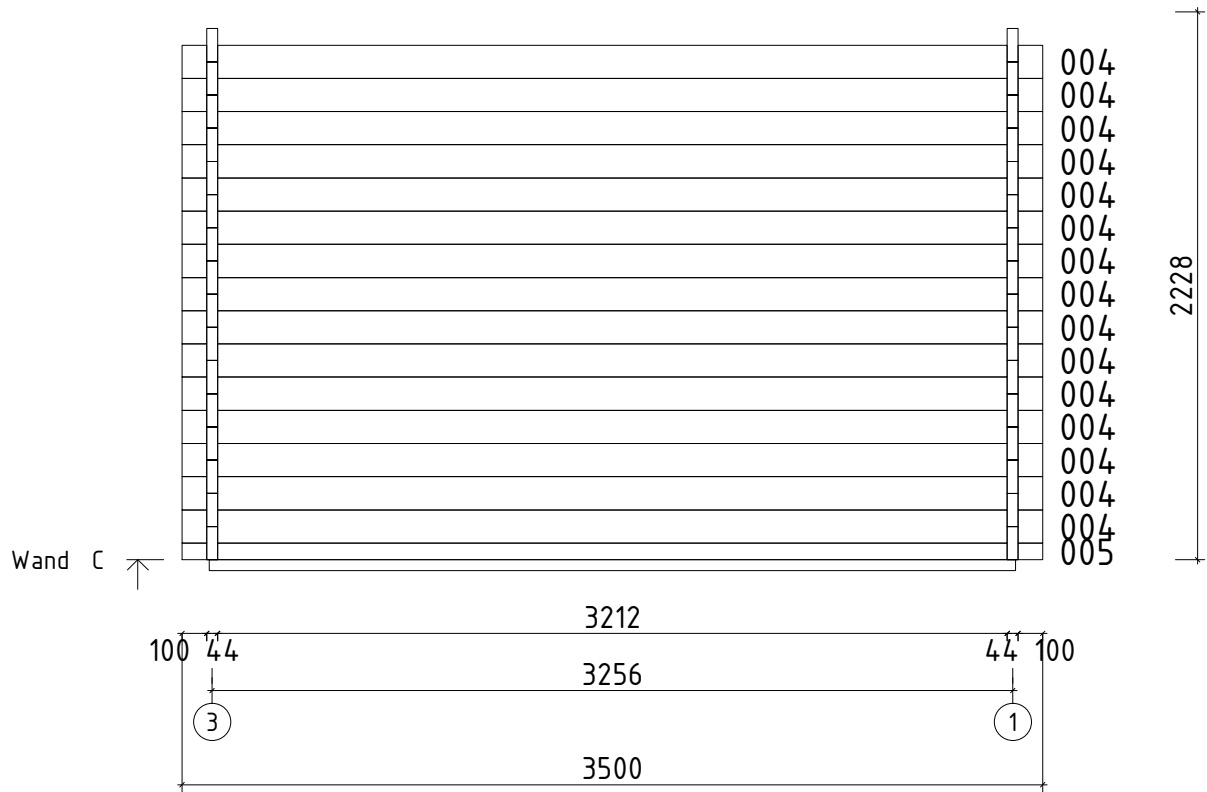

# Giebeldach für Malaga 44-A Klassik



Malaga 44-A Klassik

Kontrolliert durch:

Achtung: Alle angegebenen Maße sind ca.-Maße!

# 3D-Darstellung und Grundriss Giebeldach für Malaga 44-A Klassik

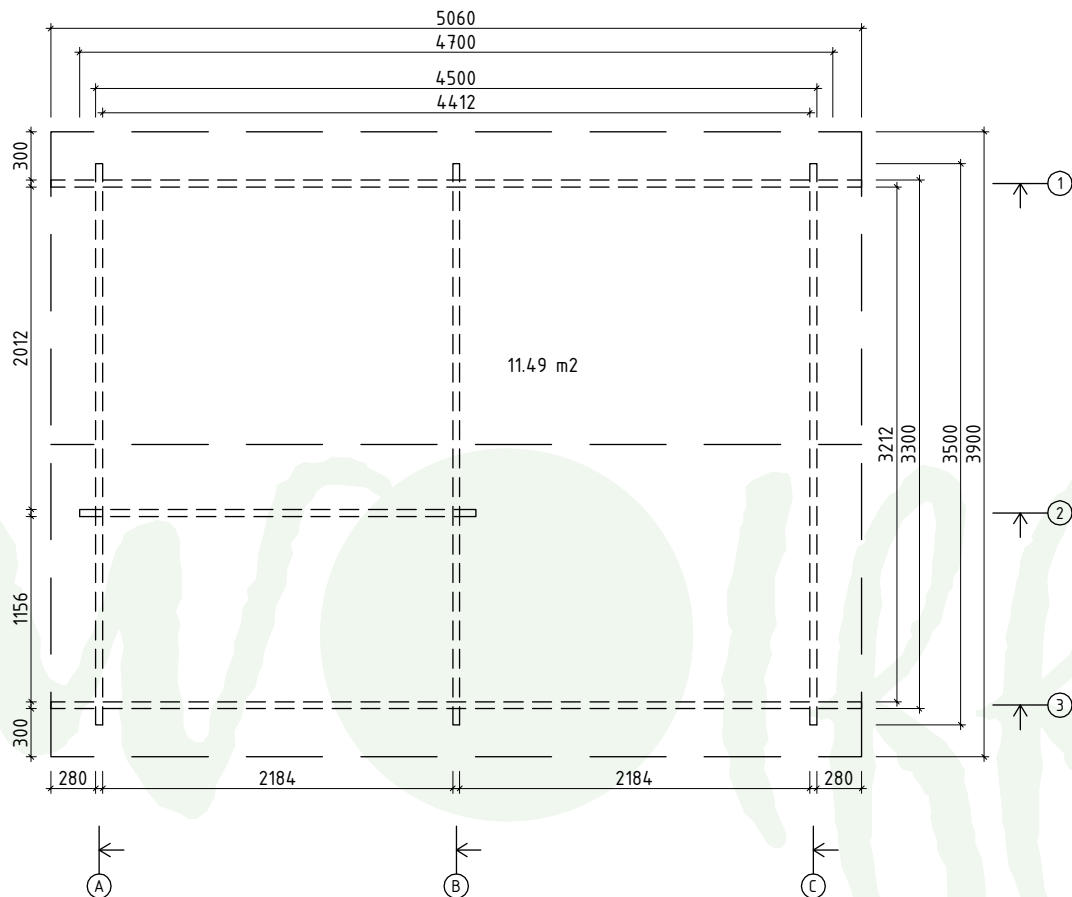
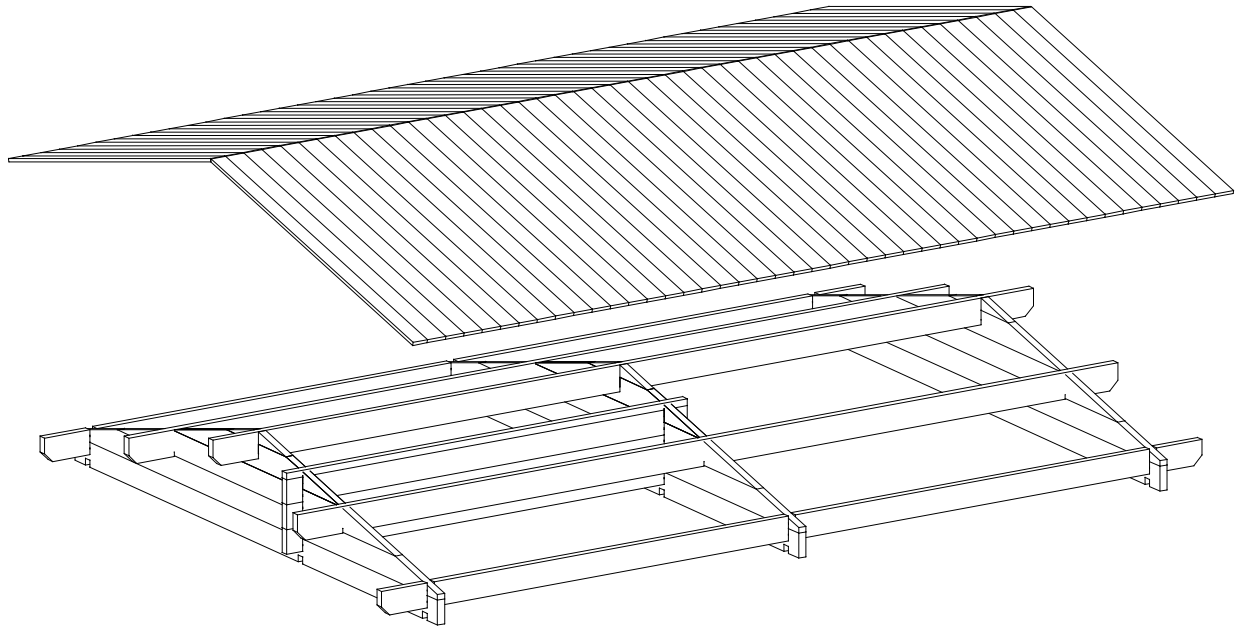

# Teileliste 1

## Giebeldach für Malaga 44-A Klassik

| Pos  |   | Stck | Profil (mm) | Länge (mm) |
|------|---|------|-------------|------------|
| 001  |   | 2    | 44x135      | 5060       |
| 002  |   | 1    | 44x135      | 3500       |
| 003  |   | 2    | 44x135      | 3500       |
| 004  |   | 1    | 44x135      | 3500       |
| 005  |   | 2    | 44x135      | 3500       |
| 006  |   | 2    | 44x135      | 2684       |
| 007  |   | 1    | 44x135      | 2684       |
| 008  |   | 1    | 44x37       | 2472       |
| 009  |   | 3    | 44x135      | 2472       |
| 010  |   | 2    | 44x135      | 1628       |
| 011  |   | 1    | 44x135      | 1628       |
| 012  |   | 6    | 44x68       | 264        |
| DB1  |   | 3    | 44x145      | 5060       |
|      | DACHBRETTER   | 90+1 | 113x18      | 2015       |
| G1-1 | GIEBELBRETTER 120X18  | 4    | 120x18      | 2095       |
| G5-1 | GIEBELDECKLEISTE 58X18  | 4    | 58x18       | 2095       |
| T2-1 | TRAUFENBRETTER 90X18  | 2    | 90x18       | 5060       |
| T4-1 | TRAUFENLEISTE 40x18   | ✓    | 40x18       | 11,0 lfm   |
| GS   | Giebelsegment   | 2    |             |            |
| SH   | Schlaghölzer  | 3    |             |            |
| NG1  | NÄGEL 2.5x50 Dachbretter                                      | 540  |             |            |
| SR01 | SCHRAUBEN 3.0x30 Traufenleisten 40x18                         | 24   |             |            |
| SR03 | SCHRAUBEN 3.5x45 Giebelbretter, Traufenbretter, Giebelsegment | 68   |             |            |
|      | ✓ - bitte selber anpassen (falls nötig)!                      |      |             |            |



# Wandplan 1 und 2

## Giebeldach für Malaga 44-A Klassik

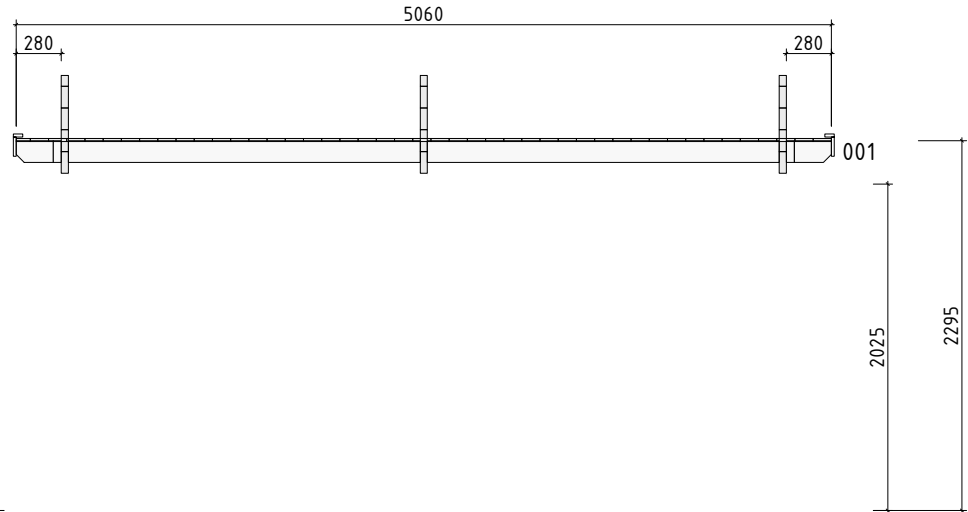
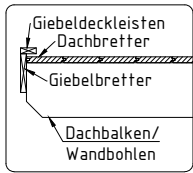

Wand 1 ↗

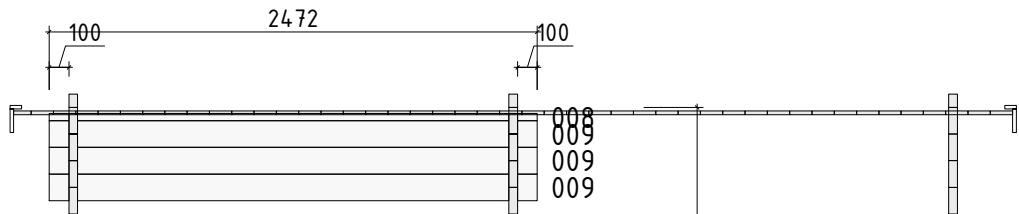
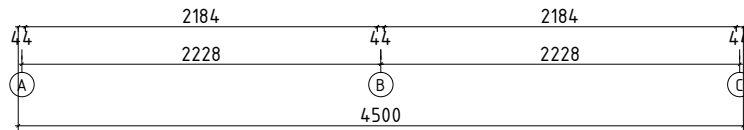

Wand 2 ↗

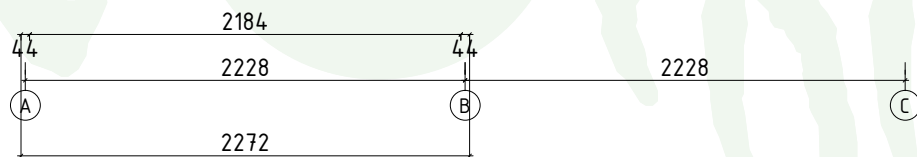

# Wandplan 3

## Giebeldach für Malaga 44-A Klassik

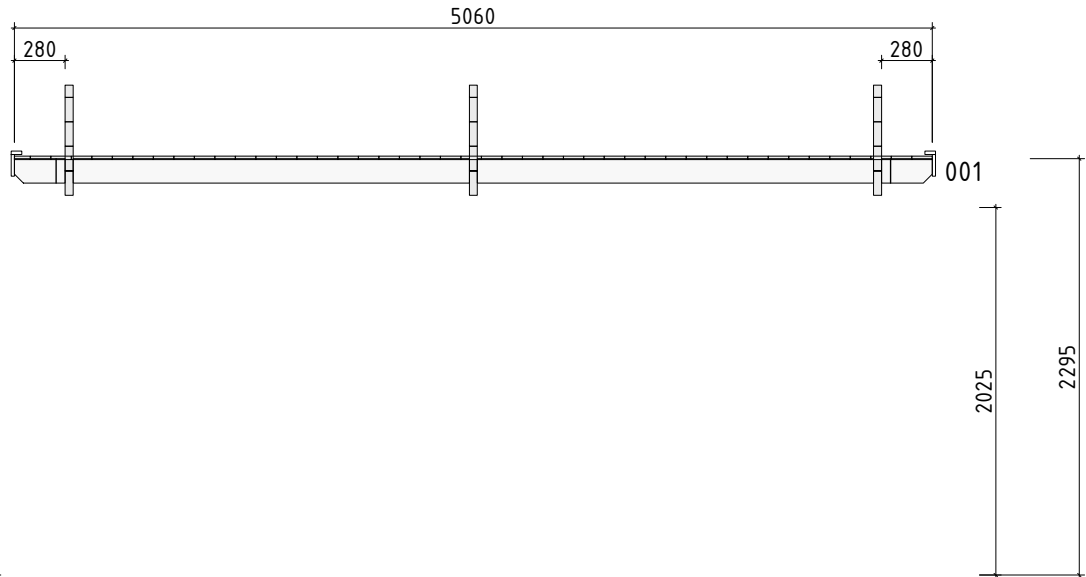

Wand 3 ↗

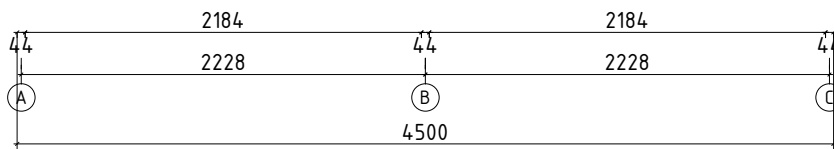

# Wandplan A und B

## Giebeldach für Malaga 44-A Klassik

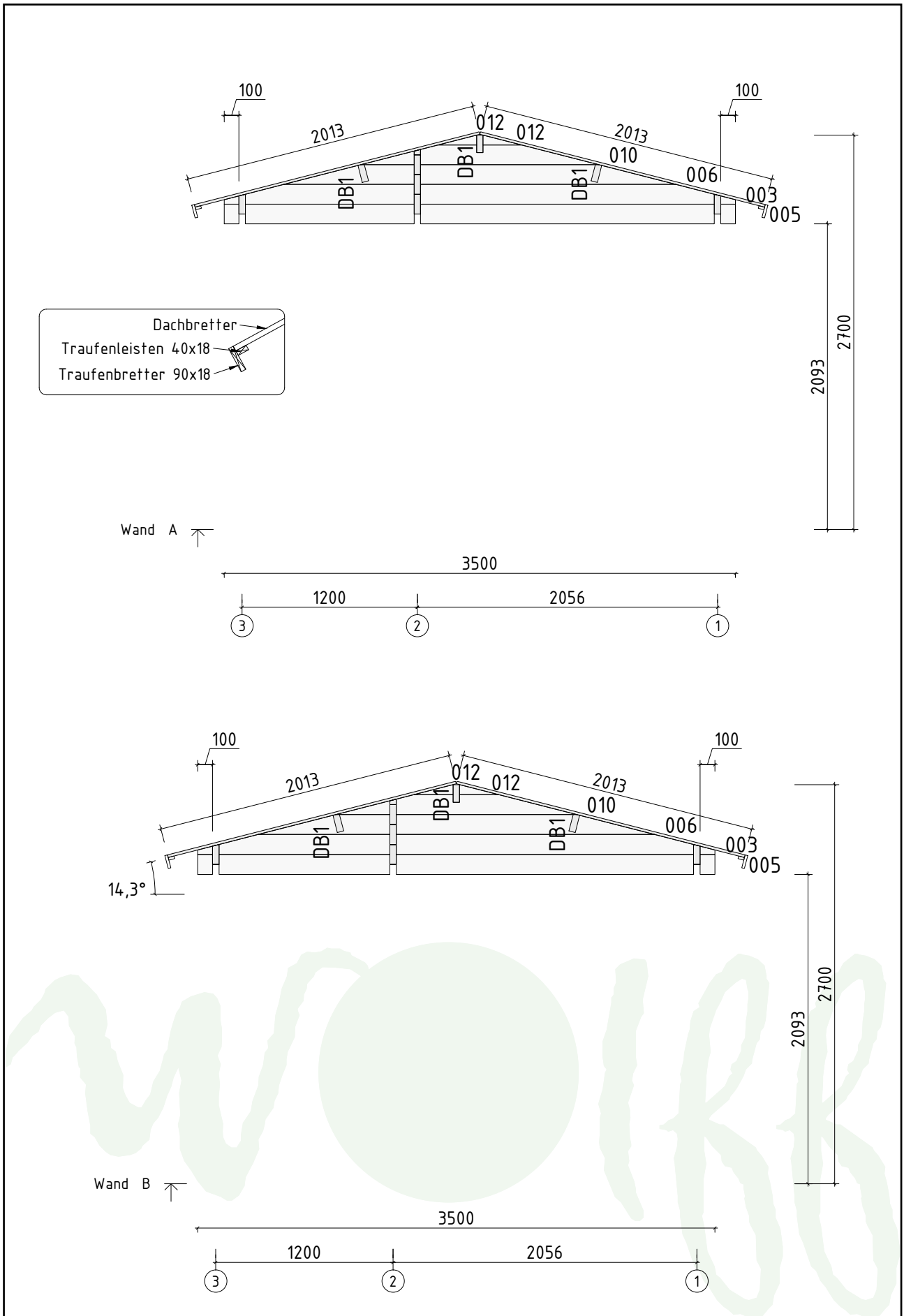

# Wandplan C

## Giebeldach für Malaga 44-A Klassik

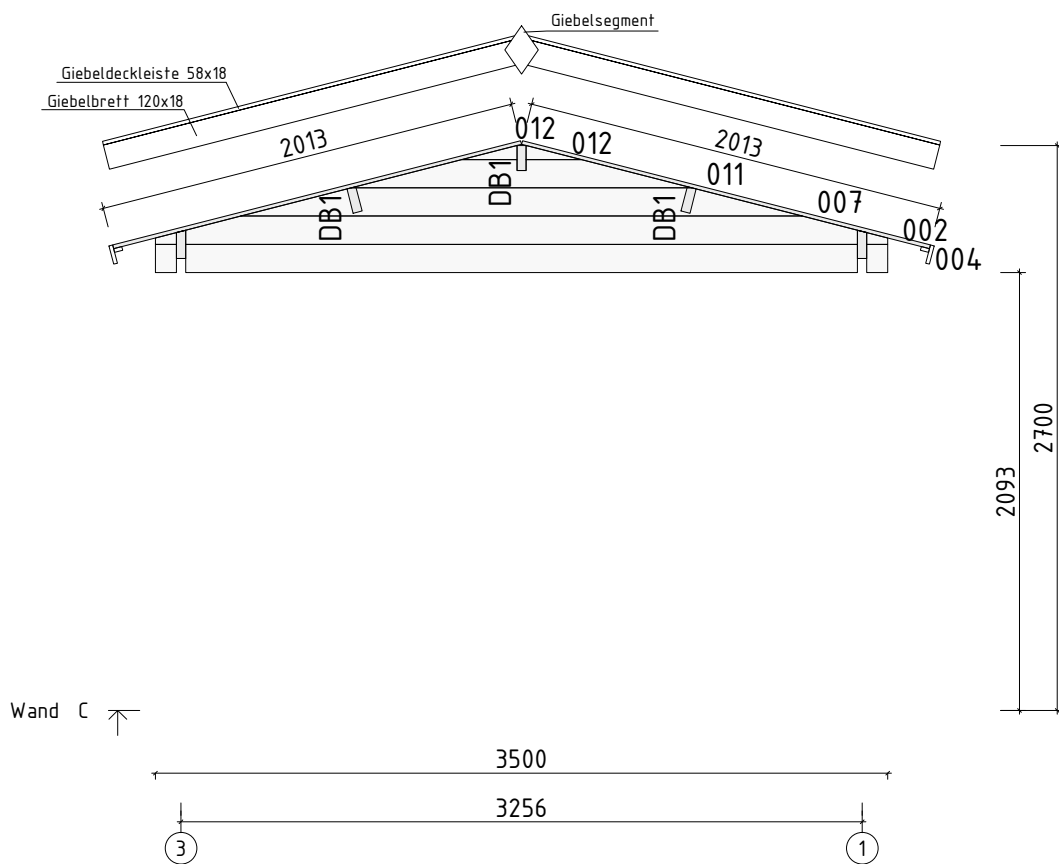

# Fenster und Türen

## Malaga 44-A Klassik



Malaga 44-A Klassik



Kontrolliert durch:

Achtung: Alle angegebenen Maße sind ca.-Maße!

# Teileliste 1

## Fenster und Türen Malaga 44-A Klassik

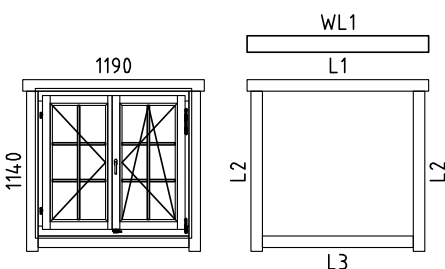
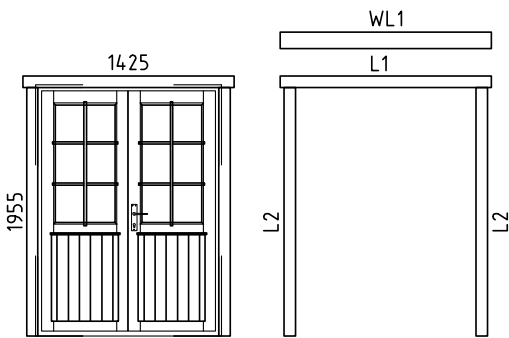
### Spezifikation für Fenster und Türen Malaga A - Set KLASSIK

|      |   |  |    |  |
|------|---|--|----|--|
|      | <p>FENSTER 1190x1140</p>  <p>A68-7</p> <p>L1 18x90 L=1430mm 2 Stck.<br/>L2 18x90 L=1260mm 4 Stck.<br/>L3 18x90 L=1190mm 2 Stck. ✓<br/>WL1 36x129 L=1430mm 1 Stck.</p> <p>Durchgangsmaß: 1034x969</p> | 1  |    |  |
|      | <p>TÜR 1425x1955</p>  <p>TU3-GH+</p> <p>L1 18x90 L=1665mm 2 Stck.<br/>L2 18x90 L=1955mm 4 Stck. ✓<br/>WL1 36x129 L=1665mm 1 Stck.</p> <p>DIN rechts</p> <p>Durchgangsmaß: 1337x1867</p>             | 1  |    |  |
| SR03 | SCHRAUBEN 3.5x45  |  | 48 |  |
| SR05 | SCHRAUBEN 4.0x60  |  | 7  |  |

✓ - Bitte selber anpassen

15.03.2017