

Art. Nr. 2838550

1/6



31.01.2020

Art. Nr. 2838550

Groundplan - Grundplan - Plan de masse - Planimetria - Plattegrond - Põhiplaan

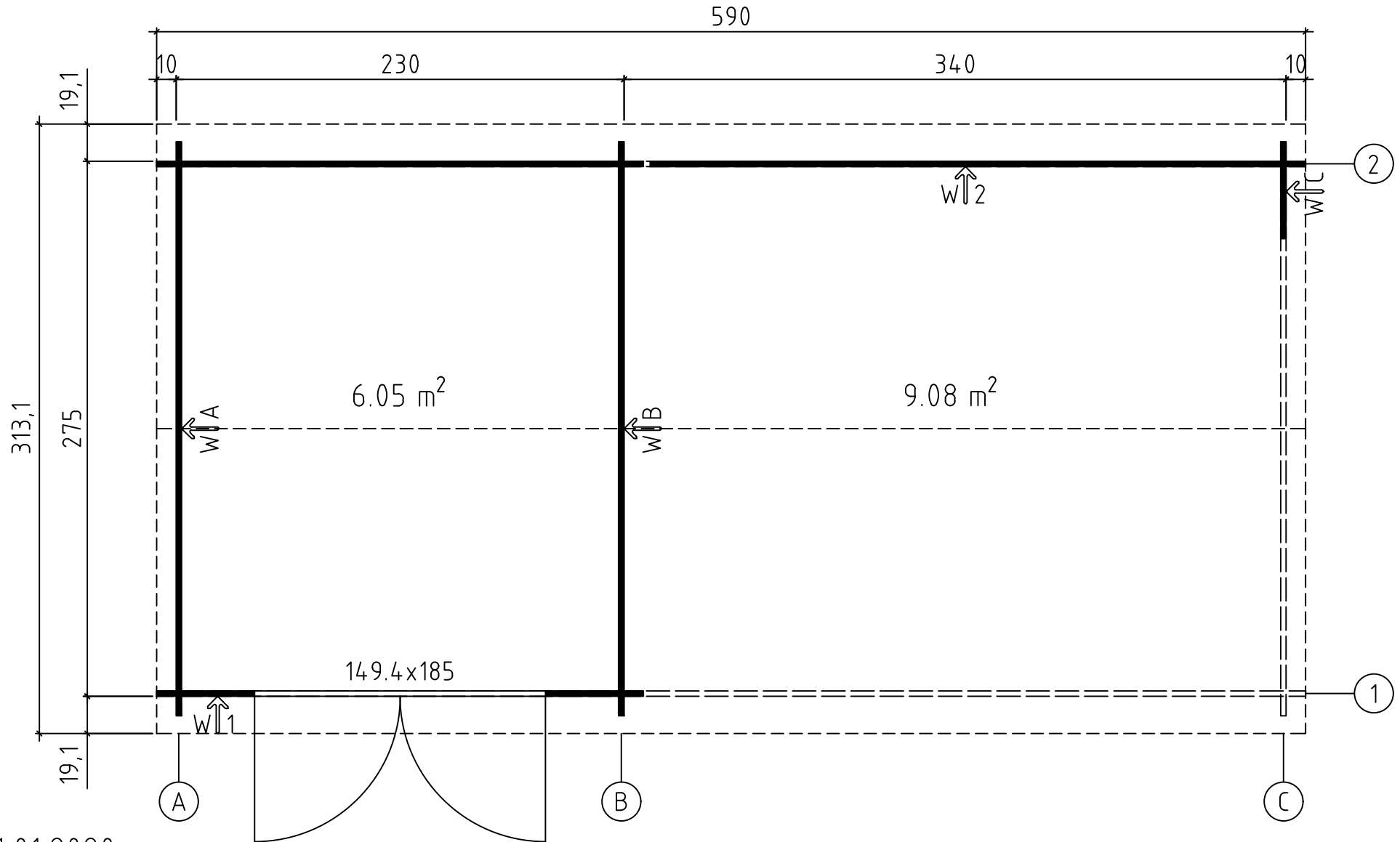

31.01.2020





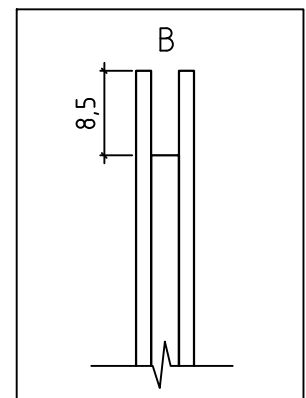
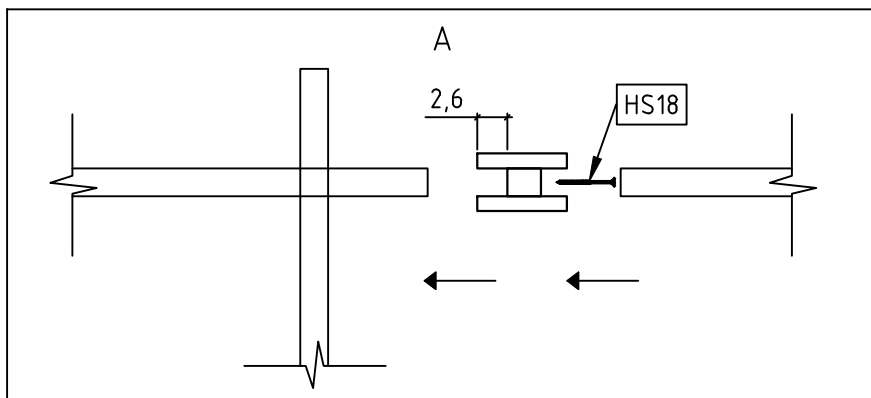
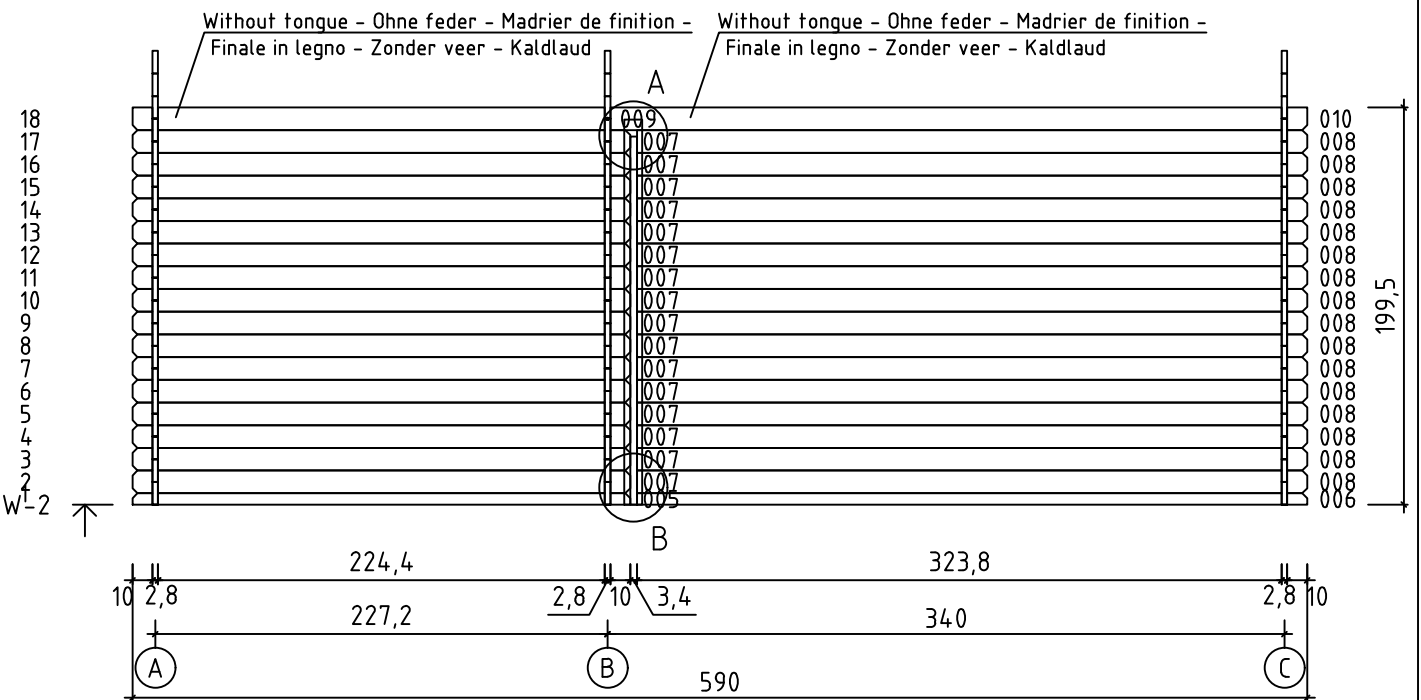
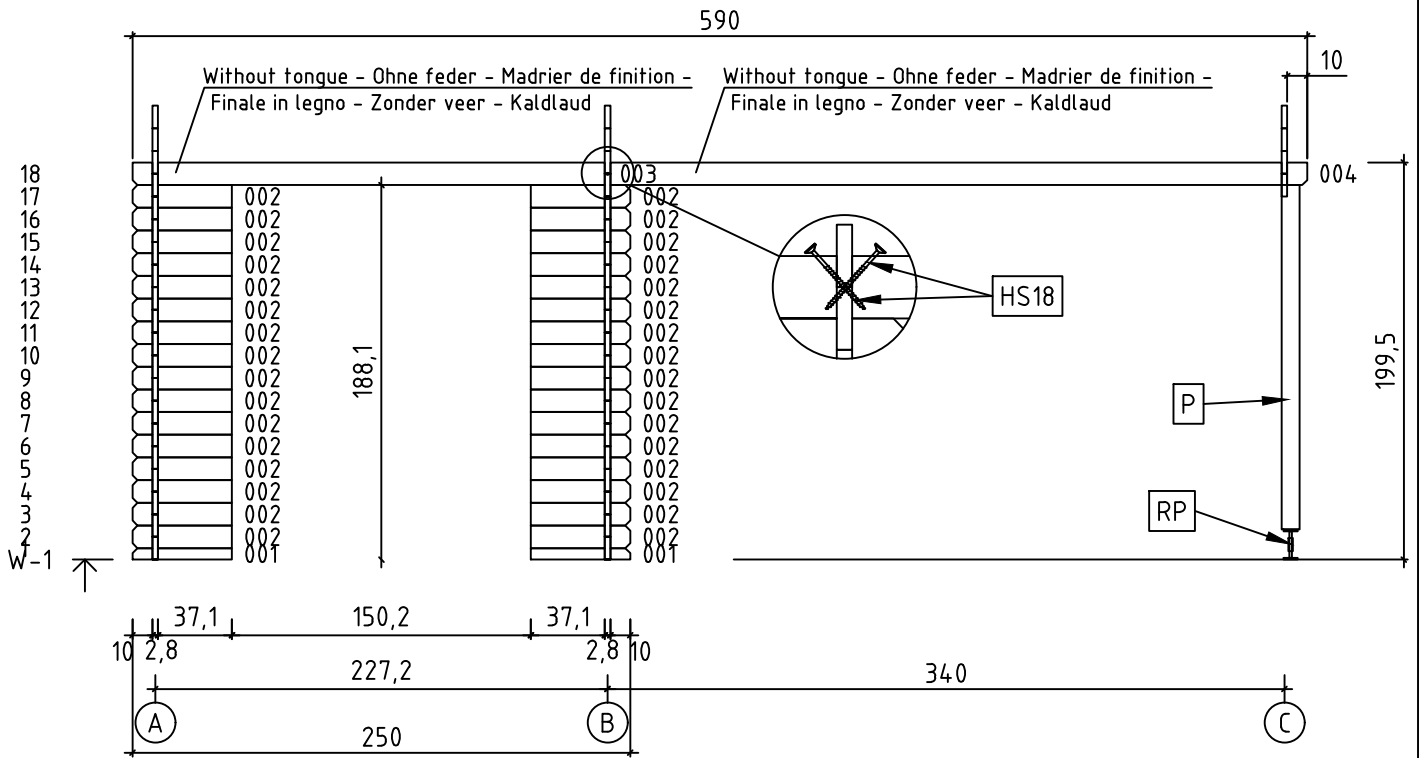

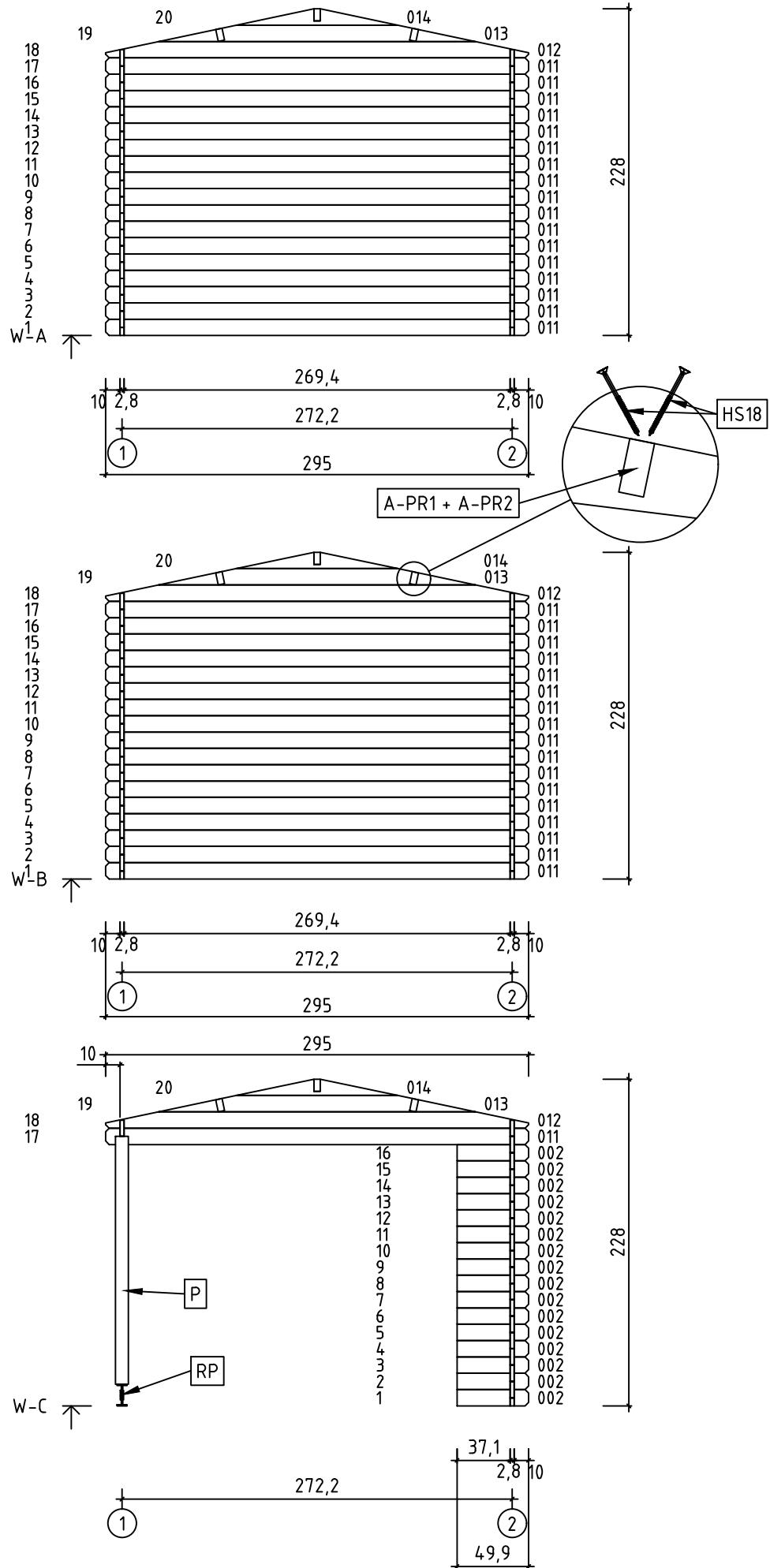

2/6



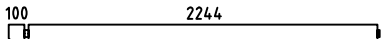
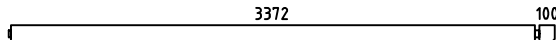
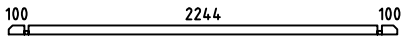
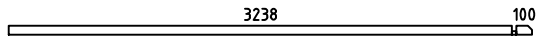
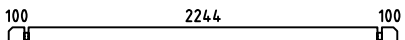
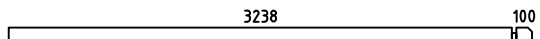
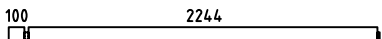
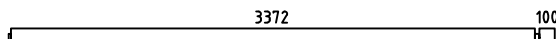
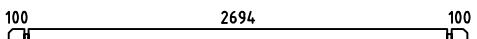
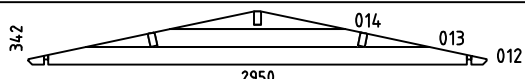
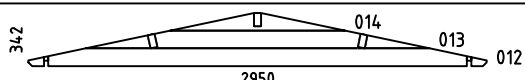
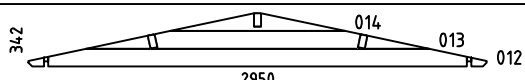
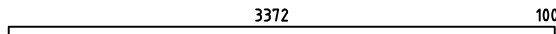
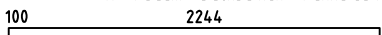

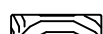

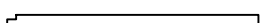

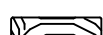
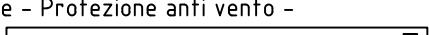

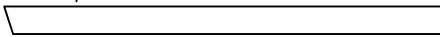
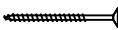
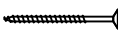
Art. Nr. 2838550

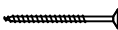
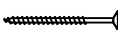
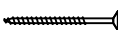
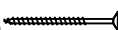
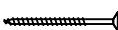
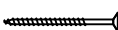

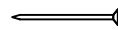
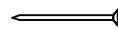

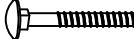



Art. Nr. 2838550

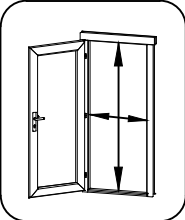
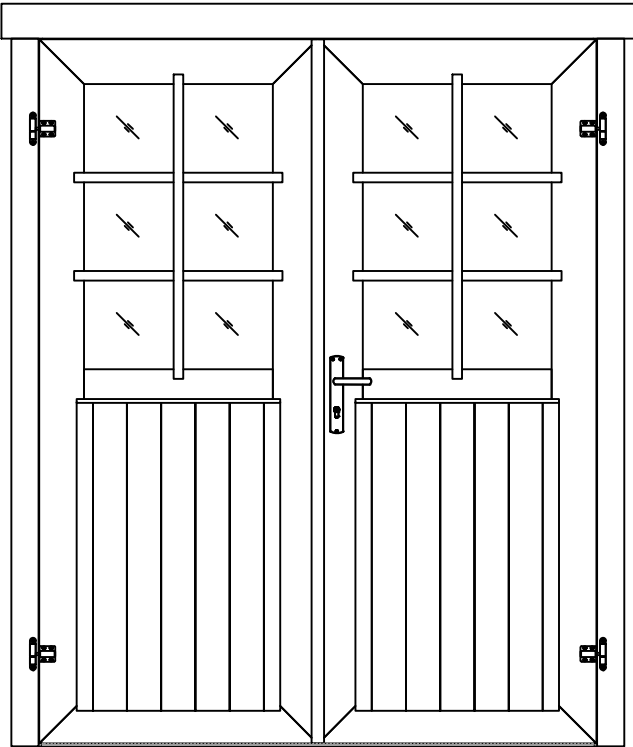

| Pos | 31.01.2020 Piece list - Stückliste - Liste des pièces - Elementi - Stuklijst - Tükítabel Art.Nr. 2838550 5/6 | Q | P (mm) | L (mm) |
|-------|---|-----|-----------|-----------|
| 001 |  | 2 | 28x57 | 499 |
| 002 |  | 48 | 28x114 | 499 |
| 003 |  | 1 | 28x120 | 2386 |
| 004 |  | 1 | 28x120 | 3514 |
| 005 |  | 1 | 28x57 | 2500 |
| 006 |  | 1 | 28x57 | 3366 |
| 007 |  | 16 | 28x114 | 2500 |
| 008 |  | 16 | 28x114 | 3366 |
| 009 |  | 1 | 28x120 | 2386 |
| 010 |  | 1 | 28x120 | 3514 |
| 011 |  | 35 | 28x114 | 2950 |
| WA-1 |  | 1 | | |
| WB-1 |  | 1 | | |
| WC-1 |  | 1 | | |
| A-PR2 | Roof beam - Dachbalken - Panne de toit - Perlina del tetto - Gordingen / dakbalk - Pärlin  | 3 | 44x140 | 3514 |
| A-PR1 | Roof beam - Dachbalken - Panne de toit - Perlina del tetto - Gordingen / dakbalk - Pärlin  | 3 | 44x140 | 2386 |
| | Roof boards - Dachbretter - Voliges - Perlina per tetto - Dakhout - Katuselaud  | 132 | 90x15 | 1600 |
| | Roofing felt fillet - Dachpappenleiste - Baguette de fixation du feutre bitumeux - Asse per fissaggio guaina bituminosa - Afdekljst asfaltpapier - Katusepapiilist  | 4 | 15x45 | 1650 |
| DPP-1 | Roofing felt (strip) - Dachpappe (bahnen) - Feutre bitumeux (bande) - Cartone catramato - Asfaltpapier (baan) - Katusepapp  | 4 | | 6000 |
| P | Post - Pfosten - Poteau - Piede registrabile - Stijl - Post  | 1 | 90x90 | 1730 |
| | H-profile - H-profiils - Profile h - Profilo ad h - H-profiel - H-profiil  | 1 | 90x58 | 1935 |
| DRV-1 | Roof edge reinforcement - Dachrandverstärkung - Corniere de renfort de bord de toit - Rinforzo x tetto - Dakrand versterking - Räästatugevdus  | 4 | 15x45 | 2950 |
| KFS-1 | Storm protection - Sturmleiste - Latte anti-tempete - Protezione anti vento - Stormverankering / beveiliging - Tormikinnitusliist  | 5 | 22x45 | 2050 |

| Pos | 31.01.2020 Piece list - Stückliste - Liste des pièces - Elementi - Stuklijst - Tükitalabel Art.Nr. 2838550 6/6 | Q | P (mm) | L (mm) |
|------|--|-----|-----------|-----------|
| | U-profile - U-profils - Profile u - Profilo ad u - U-profiel - U-profiil  | 1 | 28x58 | 1780 |
| | Gable moulding - Giebelleiste - Planche de rive - Finitura per frontale e retro del tetto - Gevellijst - Viitulaud  | 4 | 15x120 | 1650 |
| HS8 | Screw for gable segment - Schrauben für deckblatt - Vis pour fixation losange de finition - Viti x frontali tetto - Schroef voor gevelpunt segment - Kruvi rombile  | 4 | 3.5x35 | |
| HS9 | Screw for u-profile - Schraube zur befestigung u-profils - Vis a tete fraisée pour profil u - Vite per profilo ad u - Schroef ter bevestiging u-profiel - Kruvi U-profiilite  | 6 | 3.5x50 | |
| HS9 | Screw for gable moulding - Schrauben für giebelleiste - Vis pour fixation planche de rive - Vite per fissare finiture davanti e dietro del tetto - Schroef voor gevellijst - Kruvi viitulauale  | 24 | 3.5x50 | |
| HS4 | Screw for roof edge reinforcement - Schrauben für dachrandverstärkung - Vis pour fixation corniere renfort de bord de toit - Viti x rinforzo bordo tetto - Schroef voor dakrand versterking - Kruvi räästatugevdusele  | 28 | 3x30 | |
| HS14 | Screw for post - Schrauben für pfosten - Vis de fixation des poteaux - Viti per inviare - Schroef voor stijlen - Kruvi postile  | 2 | 4.5x80 | |
| HS18 | Screw for roof beams - Schrauben für dachbalken - Vis pour fixation pannes de toit - Viti per perline del tetto - Schroef voor gordingen / dakbalken - Kruvi pärlinitele  | 12 | 5x120 | |
| HS18 | Screw for wall details - Schraube für wand details - Vis pour mur details - Viti per elementi della porta - Schroef voor wand details - Kruvi seinadetailidele  | 4 | 5x120 | |
| HS18 | Screw for gable - Schrauben für giebel - Vis pour fixation des pignons - Viti per timpano - Schroef voor gevelpunt - Kruvi viilude kinnitamiseks  | 6 | 5x120 | |
| HS20 | Screw for post height adjustment - Schrauben für regulierungsschraube für pfosten - Vis de fixation de support réglable de poteau - Viti per fissare ed aggiustare l'altezza del palo verticale - Schroef voor hoogte instelling stijlen - Kruvi vajumispolite  | 8 | 6x50 | |
| SH28 | Hammer block - Schlagholz - Calle de frappe - Blocco di legno da usare come cuscinetto quando si usa il martello - Slagklos - Löögiklots  | 1 | | |
| SFS | Nut for storm protection - Schraubenmutter für sturmleiste - Ecrou pour latte anti-tempete - Dado x asta protezione vento - Moer voor stromverankering - Mutter tormikinnitusliistule  | 10 | D6 | |
| NF4 | Zn nail for roof - Zn nägel für dachbretter - Pointe pour fixation voliges de toit - Chiodi x perline tetto - Spijker(nagel) voor dakhout - Nael katuselauale  | 414 | 2x50 | |
| NF5 | Zn nail for roofing felt fillet - Zn nägel für dachpappenleiste - Pointe pour baguette de fixation feutre bitumeux - Chiodi x carta bituminosa x tetto - Spijker(nagel) voor asfaltpapier afdekljst - Papilistunael  | 16 | 2x40 | |
| NF6 | Roofing nails for roofing felt - Nägel für dachpappe - Pointe pour fixation feutre bitumeux - Chiodi per cartone catramato - Asfaltnagel - Papinael  | 205 | 2.8x15 | |
| BFS | Bolt for storm protection - Bolzen für sturmleiste - Boulon pour latte anti-tempete - Bullone x asta protezione vento - Bout voor stormankerlat - Puidupolt tormikinnitusliistule  | 10 | 6x60 | |
| GS | Gable segment - Deckblatt - Losange de finition - Decorazione in legno x frontale tetto - Gevelpunt segment - Romb  | 2 | | |
| DFS | Washer for storm protection - Dichtscheibe für sturmleiste - Rondelle pour latte anti-tempete - Rondella x asta protezione vento - Afdichtring voor storm strip - Seib tormikinnitusliistule  | 10 | D6 | |
| RP | Post height adjustment - Regulierungsschraube für pfosten - Support réglable de poteau - Piede registrabile in altezza - Stelschroef voor stijlpost - Vajumispolite  | 1 | D20 | |
| | Door - Tür - Porte - Porte - Deur - Uks 1494x1850 TUK.2.056.SVP.MMX28 SGA+28 | 1 | | |
| | | | | |
| | | | | |

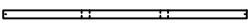
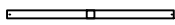
| Pos | 19.12.2017 | Piece list - Stückliste - Liste des pièces - Elementi - Stuklijst - Tükítabel 14 94x1850 TUK.2.056.SVP.MMX28 SGA+28 | 1/2 | Q | P (mm) | L (mm) |
|--|--|--|---|---|---|-----------|
| Glass size - Glasgröße - Taille de la vitre - Misura del vetro - Glas afmeting - Klaasi mõõt: 502x750 mm | | | | |  1418x1794 mm | |
|  | | | | | | |
| 1 | Upper door jamb - Türrahmen oben - Cadre de porte supérieur - Telaio superiore della porta - Bovendorpel - Ukse ülemine leng | |  | 1 | 66x100 | 1438 |
| 2 | Left door jamb - Türrahmen links - Cadre de porte gauche - Telaio montante sinistro della porta - Linkerstijl deurframe - Ukse vasak leng | |  | 1 | 66x80 | 1850 |
| 3 | Right door jamb - Türrahmen rechts - Cadre de porte droit - Telaio montante destro della porta - Rechterstijl deurframe - Ukse parem leng | |  | 1 | 66x80 | 1850 |
| 4 | Doorstep - Swelle - Barre de seuil - Soglia della porta - Deurdorpel - Lävepakk | |  | 1 | 20x21 | 1418 |
| 5 | Connection strip - Deckleiste - Baguette de battement - Profilo verticale della porta - Stulplijst - Kokkuvältsiliist | |  | 1 | 13x32 | 1812 |
| 6 | Georgian bars - Sprossen - Croisillons - La griglia georgiana - Raamverdeling - Petteliistud | |  | 2 | 15x25 | 784 |
| 7 | Georgian bars - Sprossen - Croisillons - La griglia georgiana - Raamverdeling - Petteliistud | |  | 4 | 15x25 | 536 |

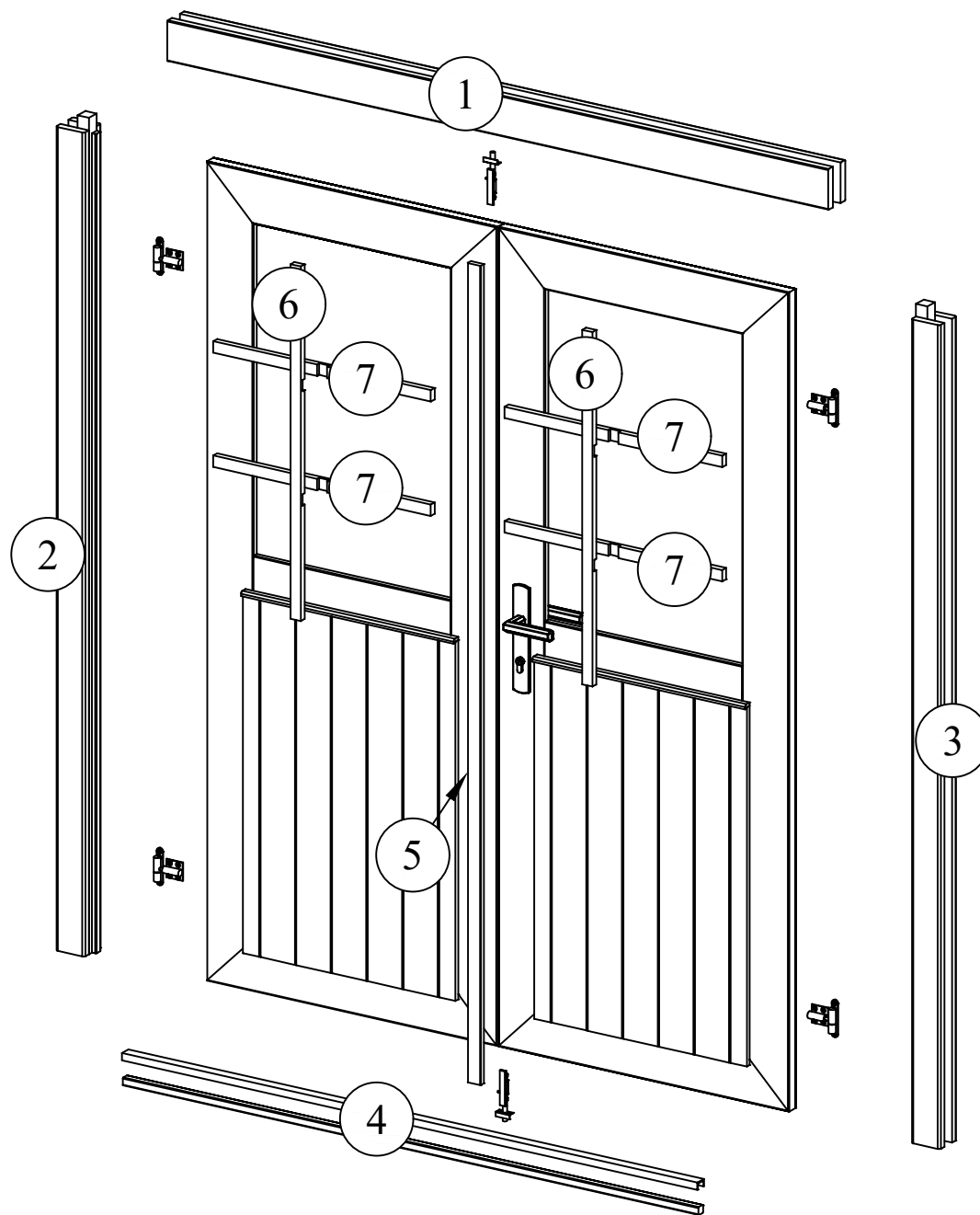

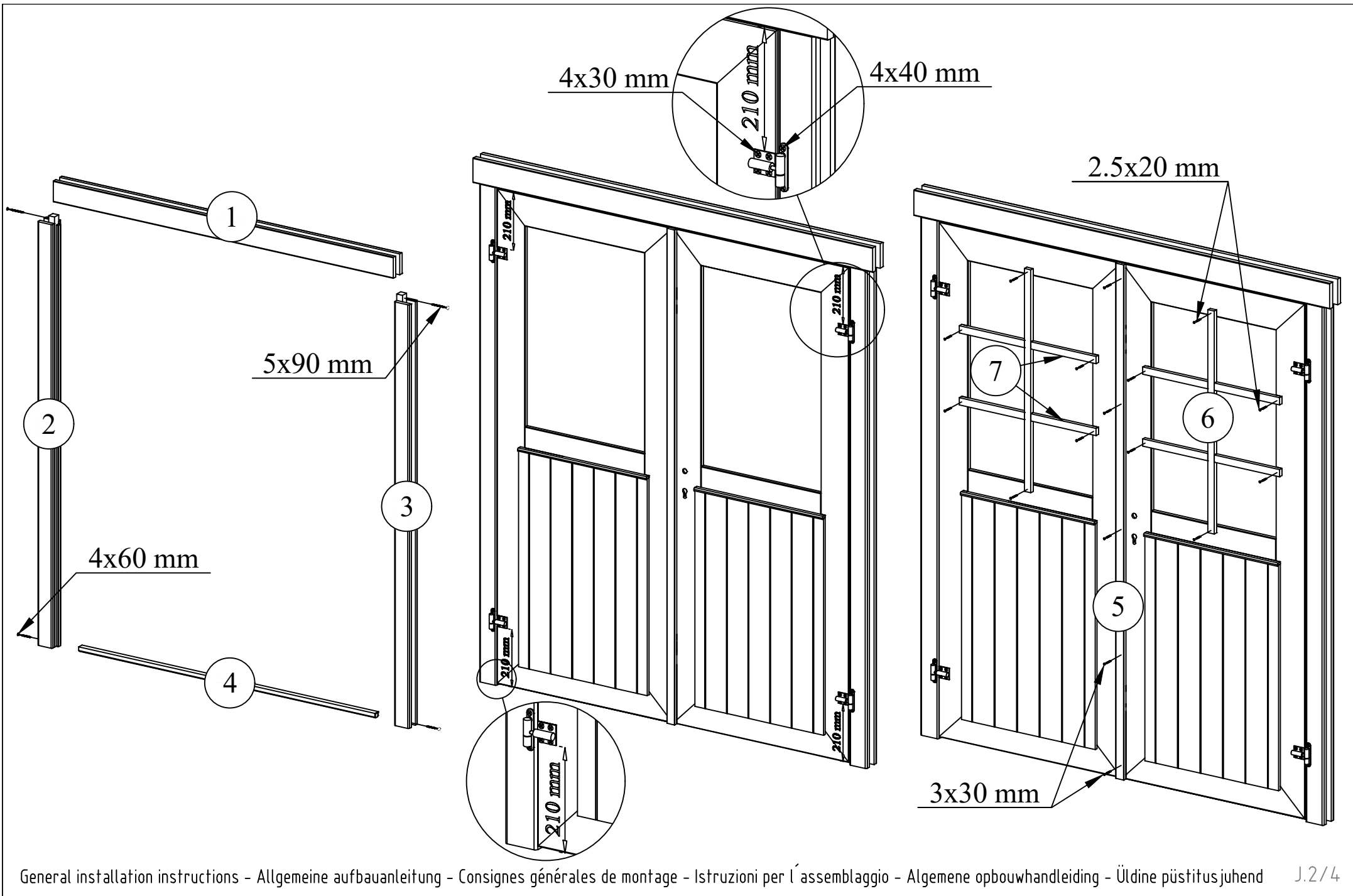

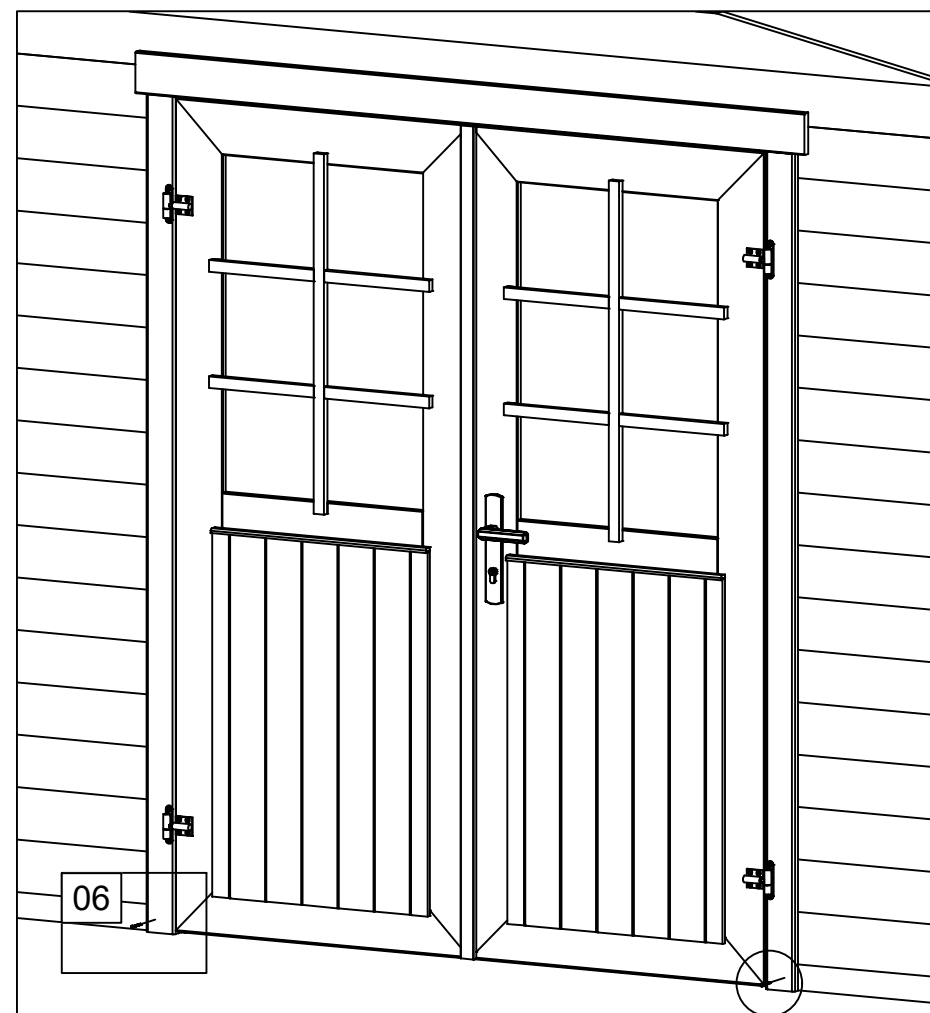
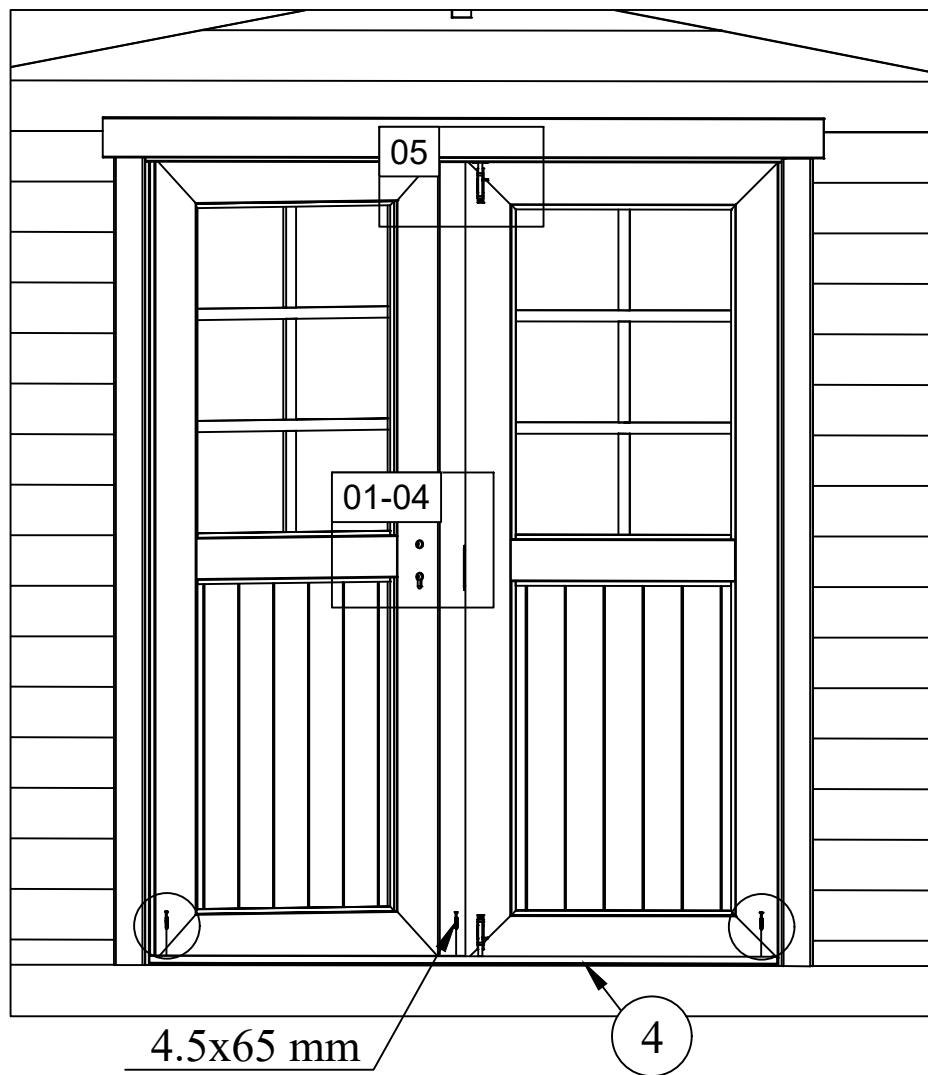

01



04

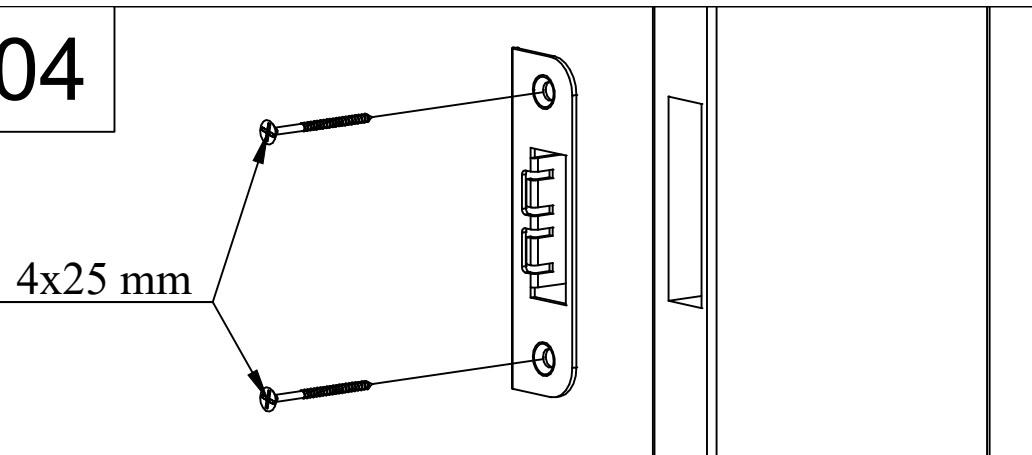

02



05

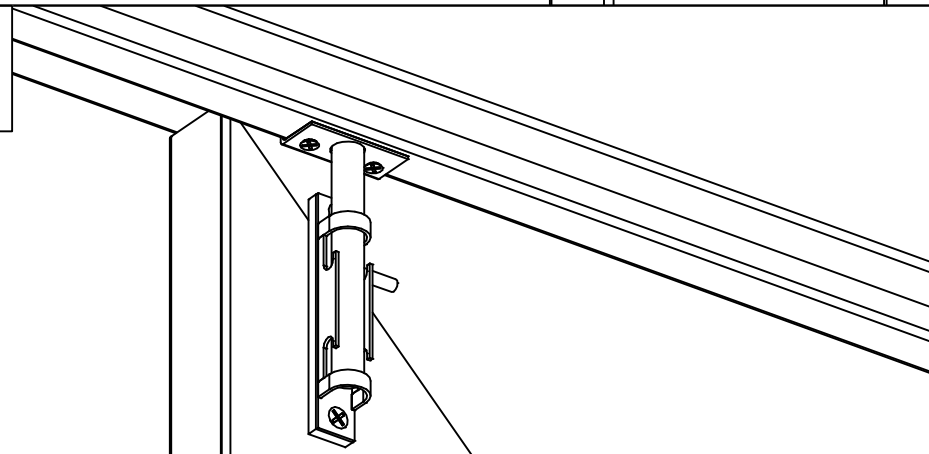

03

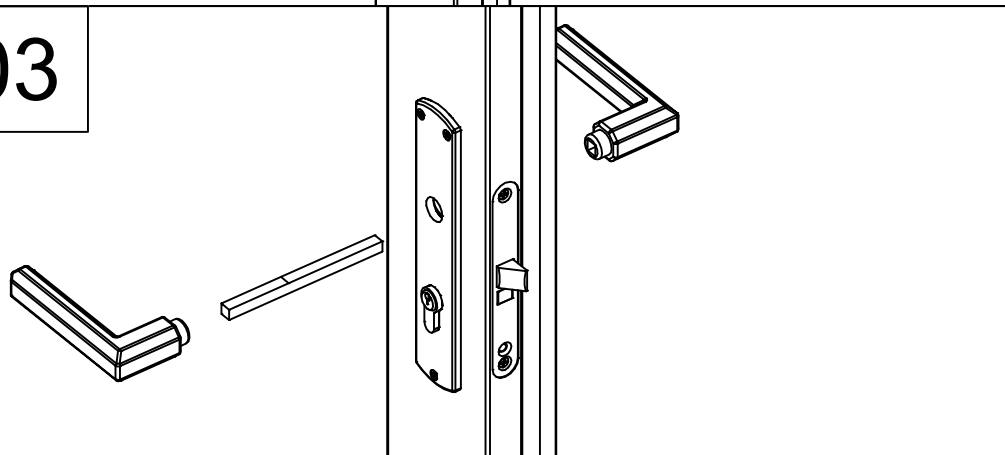

06

