

*Dorset*  
*Art. Nr. 348902*  
*1/9*

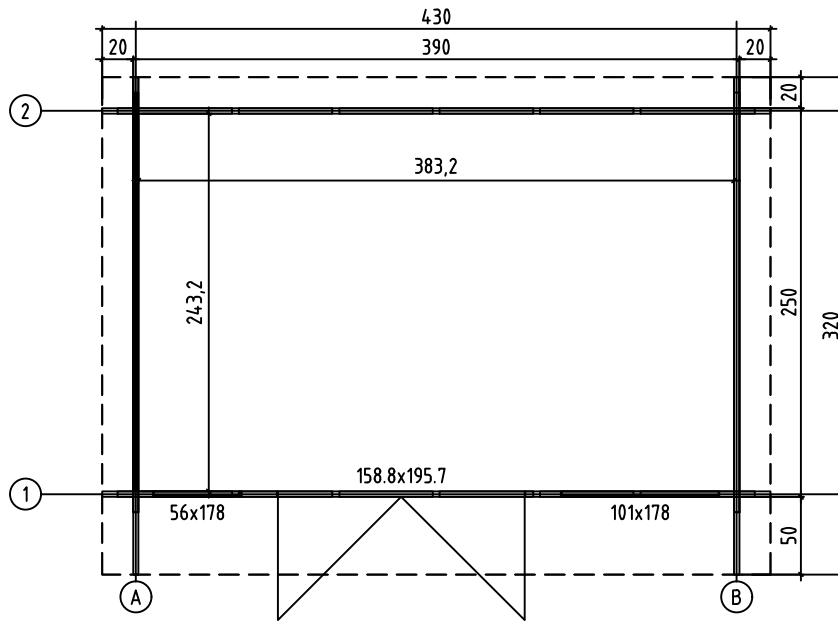

29.11.2017

Groundplan - Grundplan - Plan de masse - Planimetria - Plattegrond - Põhiplaan



Foundation - Fundament - Fondation - Fondamenta - Fundering - Immutatud alusraam

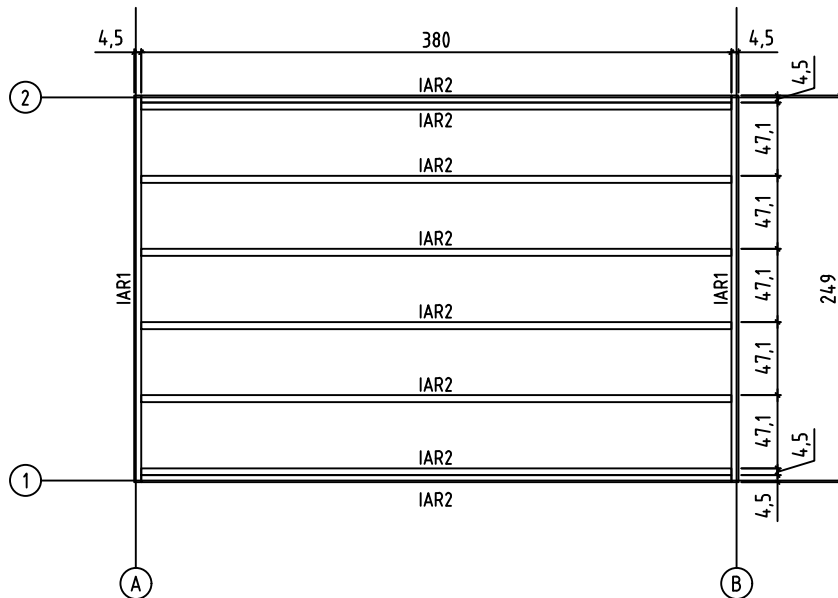



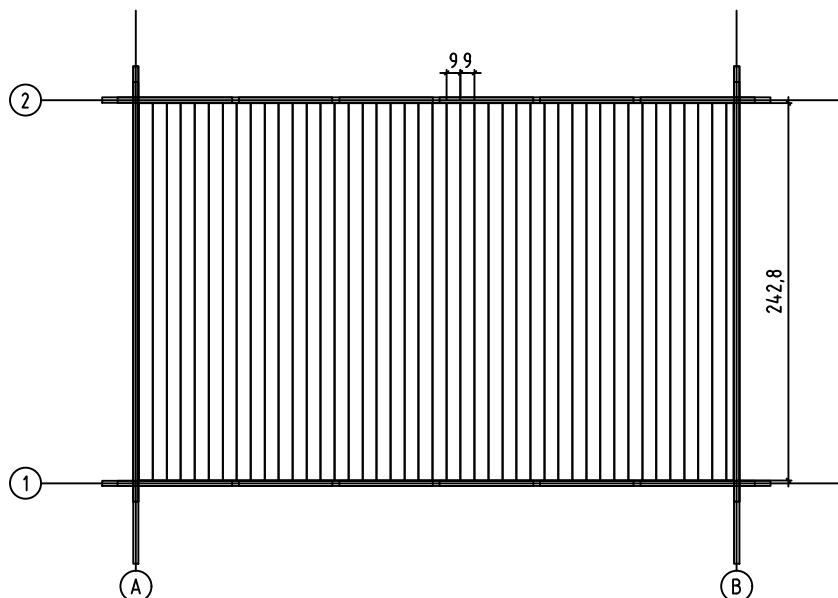

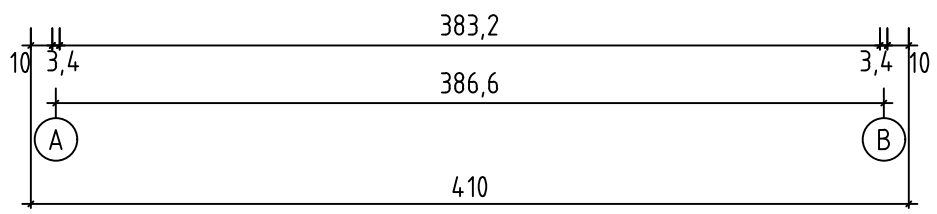
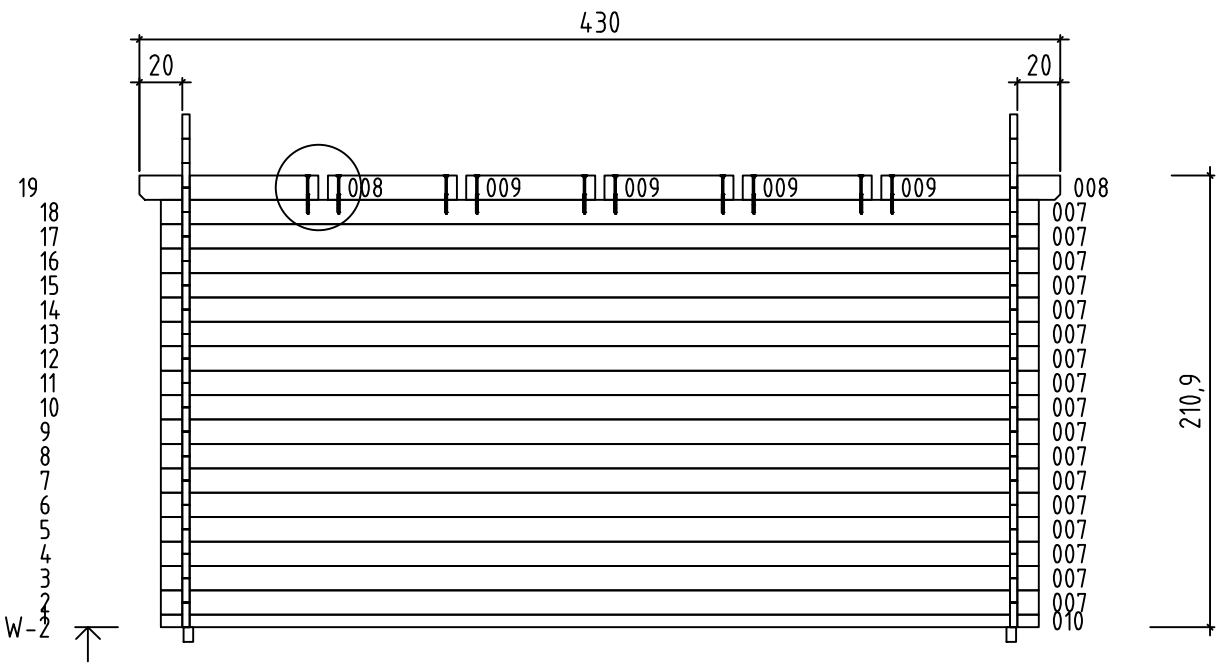
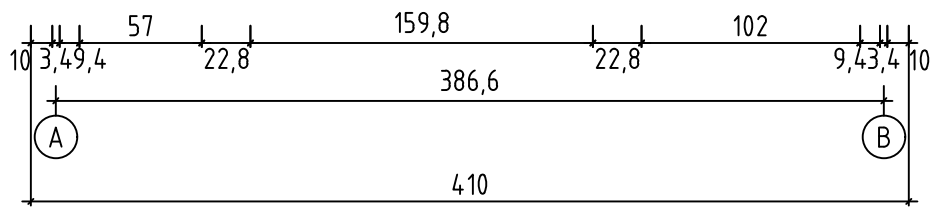
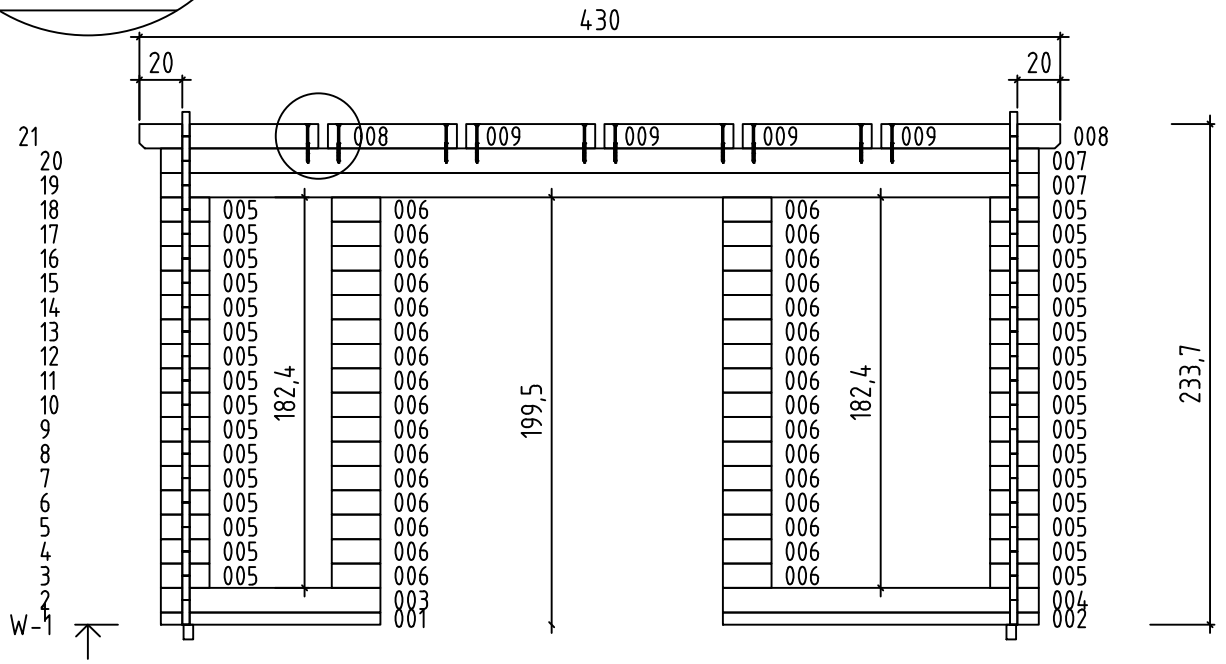
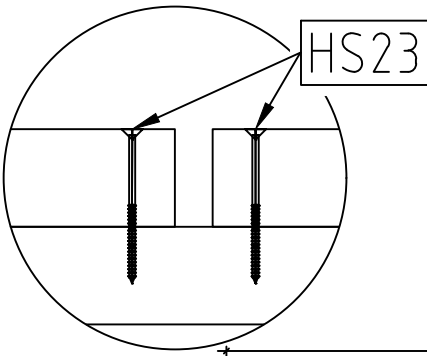

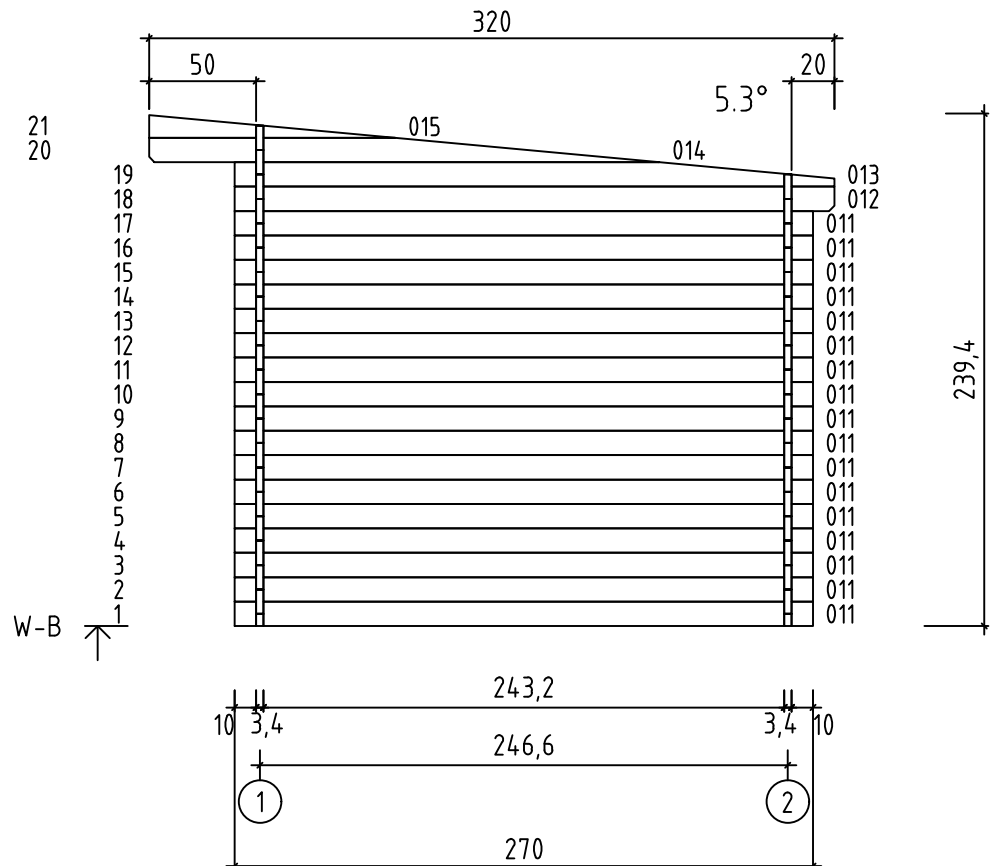
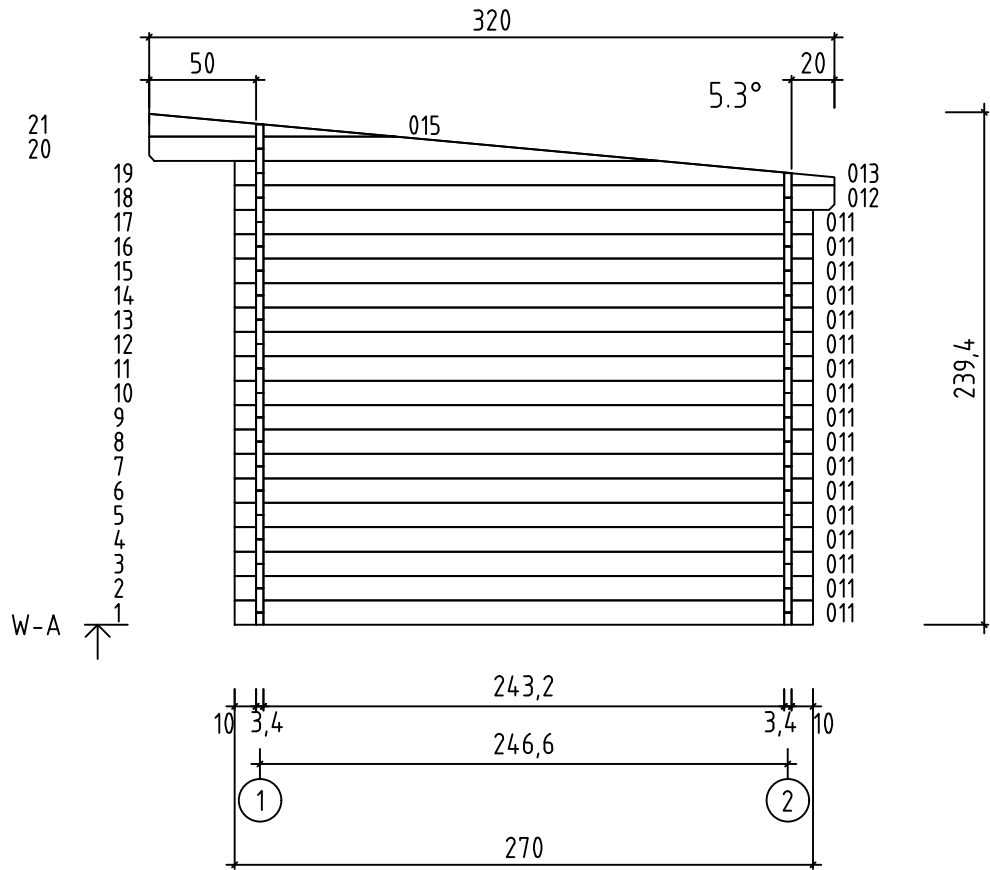

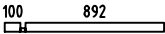
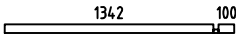
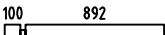
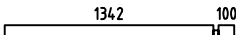

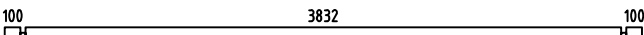
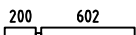
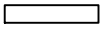
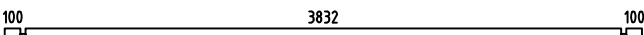
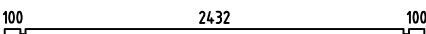
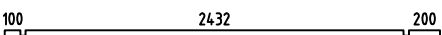
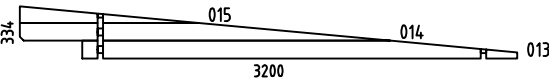
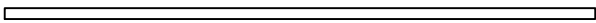
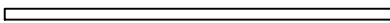
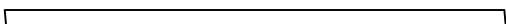





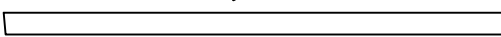



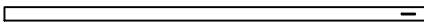
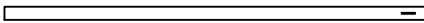
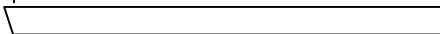
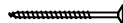
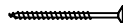
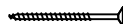
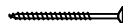
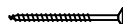

Floor boards - Fussbodenbretter - Plan pose plancher - Pavimento - Vloerhout - Põrandalaudis







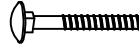



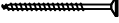
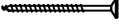
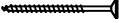

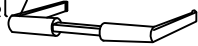

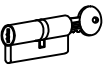
Pos	29.11.2017 Piece list - Stückliste - Liste des pièces - Elementi - Stuklijst - Tükitalabel Art.Nr. 348902 5/9	Q	P (mm)	L (mm)
001		1	34x57	1026
002		1	34x57	1476
003		1	34x114	1026
004		1	34x114	1476
005		32	34x114	228
006		32	34x114	228
007		19	34x114	4100
008		4	34x114	836
009		8	34x114	602
010		1	34x57	4100
011		34	34x114	2700
012		2	34x114	2800
WA-1 WB-1		1		
IAR2	Foundation - Fundament - Fondation - Fondamenta - Fundering - Immutatud alusraam 	8	45x70	3800
IAR1	Foundation - Fundament - Fondation - Fondamenta - Fundering - Immutatud alusraam 	2	45x70	2490
SR1	SARIKAD 	5	44x140	3227
	Floor boards - Fussbodenbretter - Lame de plancher - Pavimento - Vloerhout - Põrandalaud 	43	90x18	2428
	Roof boards - Dachbretter - Voliges - Perlina per tetto - Dakhout - Katuselaud 	36	90x18	4300
	Floor fillet - Fussbodenleiste - Corniere de finition du plancher - Finitura per pavimento (battisco pa) - Vloerafwerklijs - Põrandaliist 		18x18	12.51
	Roofing felt fillet - Dachpappenleiste - Baguette de fixation du feutre bitumeux - Asse per fissaggio guaina bituminosa - Afdeklijs asfaltpapier - Katusepapiliist 	2	18x58	3250
	Roofing felt fillet - Dachpappenleiste - Baguette de fixation du feutre bitumeux - Asse per fissaggio guaina bituminosa - Afdeklijs asfaltpapier - Katusepapiliist 	1	18x58	4220
	Fascia board - Traufbrett - Bandeau de toit - Finitura lati tetto - Gevellijs - Räästalaud 	2	18x120	3227
DRV-1	Roof edge reinforcement - Dachrandverstärkung - Corniere de renfort de bord de toit - Rinforzo x tetto - Dakrand versterking - Räästafugevdus 	2	28x34	200

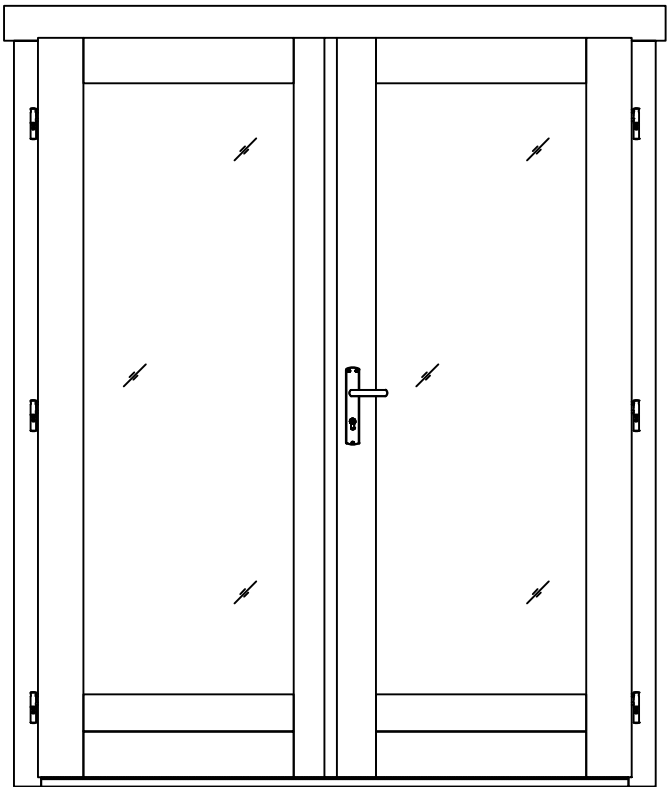
Pos	29.11.2017 Piece list - Stückliste - Liste des pièces - Elementi - Stuklijst - Tükítabel Art.Nr. 348902 6/9	Q	P (mm)	L (mm)
DRV-2	Roof edge reinforcement - Dachrandverstärkung - Corniere de renfort de bord de toit - Rinforzo x tetto - Dakrand versterking - Räästatugevdus 	2	28x34	500
DRV-3	Roof edge reinforcement - Dachrandverstärkung - Corniere de renfort de bord de toit - Rinforzo x tetto - Dakrand versterking - Räästatugevdus 	2	28x34	2440
KFS-1	Storm protection - Sturmleiste - Latte anti-tempete - Protezione anti vento - Stormverankering / beveliging - Tormikinnitusliist 	2	22x45	2050
KFS-2	Storm protection - Sturmleiste - Latte anti-tempete - Protezione anti vento - Stormverankering / beveliging - Tormikinnitusliist 	2	22x45	2500
	Gable moulding - Giebelleiste - Planche de rive - Finitura per frontale e retro del tetto - Gevellijst - Viilulaud 	3	18x120	4336
HS9	Screw for gable moulding - Schrauben für giebelleiste - Vis pour fixation planche de rive - Vite per fissare finiture davanti e dietro del tetto - Schroef voor gevellijst - Krugi viilulauale 	42	3.5x50	
HS12	Screw for fascia boards - Schrauben für traufbretter - Vis pour fixation bandeau de toit - Viti x striscia del tetto - Schroef voor gevellijst - Krugi räästalauale 	16	4x40	
HS12	Screw for roof edge reinforcement - Schrauben für dachrandverstärkung - Vis pour fixation corniere renfort de bord de toit - Viti x rinforzo bordo tetto - Schroef voor dakrand versterking - Krugi räästatugevdusele 	20	4x40	
HS18	Screw for rafter - Schrauben für dachsparren - Vis pour chevron - Vite per trave - Schroef voor dakspar - Krugi sarikatele 	10	5x120	
HS18	Screw for gable - Schrauben für giebel - Vis pour fixation des pignons - Viti per timpano - Schroef voor gevelpunt - Krugi viilude kinnitamiseks 	12	5x120	
HS16	Screw for foundation - Schrauben zur befestigung fundament - Vis de fixations des poutrelles de fondations - Viti x fondamenta - Schroef voor fundering - Krugi alusraamile 	30	5x90	
HS23	Screw for wall details - Schraube für wand details - Vis pour mur details - Viti per elementi della porta - Schroef voor wand details - Krugi seinadetailidele 	24	6x180	
NF2	Zn nail for floor fillet - Zn nägel für fussbodenleiste - Pointe pour corniere de finition du plancher - Chiodi x fissaggio pavimento - Spijker(nagel) voor vloer afdekljst - Nael põrandaliistule 	26	1.4x40	
SH34	Hammer block - Schlagholz - Calle de frappe - Blocco di legno da usare come cuscinetto quando si usa il martello - Slagklos - Löögiklots 	1		
SFS	Nut for storm protection - Schraubenmutter für sturmleiste - Ecrou pour latte anti-tempete - Dado x asta protezione vento - Moer voor stromverankering - Mutter tormikinnitusliistule 	8	D6	
NF4	Zn nail for roof - Zn nägel für dachbretter - Pointe pour fixation voliges de toit - Chiodi x perline tetto - Spijker(nagel) voor dakhout - Nael katuselauale 	271	2x50	
NF4	Zn nail for floor - Zn nägel für fussbodenbretter - Clous pour plancher - Chiodi x perline pavimento - Spijker(nagel) voor vloer - Nael põrandalauale 	264	2x50	
NF5	Zn nail for roofing felt fillet - Zn nägel für dachpappenleiste - Pointe pour baguette de fixation feutre bitumeux - Chiodi x carta bituminosa x tetto - Spijker(nagel) voor asfaltpapier afdekljst - Papiliistunael 	26	2x40	
BFS	Bolt for storm protection - Bolzen für sturmleiste - Boulon pour latte anti-tempete - Bullone x asta protezione vento - Bout voor stormankerlat - Puidupolt tormikinnitusliistule 	8	6x70	
DFS	Washer for storm protection - Dichtscheibe für sturmleiste - Rondelle pour latte anti-tempete - Rondella x asta protezione vento - Afdichtring voor storm strip - Seib tormikinnitusliistule 	8	D6	
	Window - Fenster - Fenetre - Finestra - Raam - Aken 1010x1780 TAK.1.100.TPM0.e DGP+	1		
	Window - Fenster - Fenetre - Finestra - Raam - Aken 560x1780 AK.1.100.TPSP DGP+	1		
	Door - Tür - Porte - Porte - Deur - Uks 1588x1957 TUK.1.100.TPVP.MM DGP+	1		

Pos	29.11.2017 Piece list - Stückliste - Liste des pièces - Elementi - Stuklijst - Tükítabel 1588x1957 TUK.1.100.TPVP.MM DGP+	7/9	Q	P (mm)	L (mm)
HS4	Screw for door fillet - Schraube zur befestigung türleiste - Vis pour fixation baguette d'arrêt de porte - Viti per massellino della porta - Schroef voor deurlijst - Kruvi ukse kokkuvältsiliistule		5	3x30	
HS16	Screw for door jamb - Schraube für türrahmen - Vis de fixation partie haute avec montants du cadre de porte - Viti x fissaggio montanti porte - Schroef voor deurkozijn - Kruvi ukse lengile		4	5x90	
HS25	Screw for doorstep - Schrauben für swelle - Vis pour fixation barre de seuil - Vite per soglia della porta - Schroef voor deurdorpel - Kruvi lävepakule		3	4.5x65	
MH	Male bolt hinge for door - Türband - Partie male de paumelle de porte - Cerniera anube x porta - Scharnier bout - Reguleeritav polthing isane		6	14x80	
HC	Covers for door hinges - Schutzkappe für türband - Couverture de paumelle de porte - Copertura delle cerniere della porta - Afdek kap voor deurscharnier - Reguleeritava polthinge kate		12		
TL4	Door handle fittings - Türgriff - Poignée de porte - Maniglie - Deurhendel klink - Ukse käepide		1		
TL5	Set of door lock covers - Schlossblenden - Set de garnitures de porte - Copertura serrature - Slot sluitplaat set - Ukse lukuplaaf		1		
	Cylinder lock - Zylinderschloss - Barillet de porte - Serratura - Cylinder slot - Ukse lukusüdamik		1	30x35	
	Striker for barrel bolt - Hülse für grendelriegel - Gache au sol du targette - Boccola per fermo della porta - Huls voor vergrendelingsschuif - Vasturaud ukse servariivile		2		
<p>Glass size - Glasgröße - Taille de la vitre - Misura del vetro - Glas afmeting - Klaasi mõõt: 561x1593 mm</p> <div style="display: flex; justify-content: space-between; align-items: center;"> <div style="text-align: center;">  </div> <div style="text-align: center;">  <p>1488x1875 mm</p> </div> </div>					

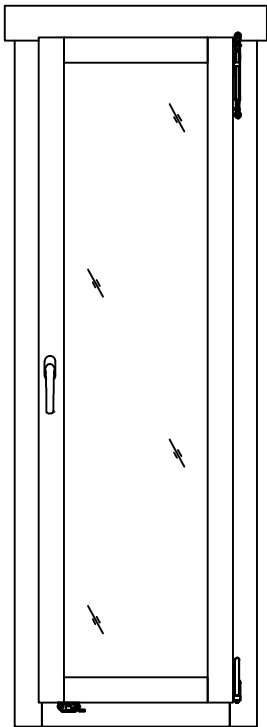
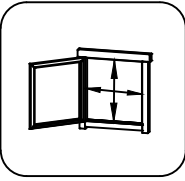
Pos	29.11.2017 Piece list - Stückliste - Liste des pièces - Elementi - Stuklijst - Tükitalabel 560x1780 AK.1.100.TPSP DGP+ 8/9	Q	P (mm)	L (mm)
FS2	Window handle fittings - Fenstergriff - Poignee de fenetre - Maniglia c/ferramenta - Raamhendel -/grendel -/klink - Aknalink	1		
<p data-bbox="256 241 1289 275">Glass size - Glasgröße - Taille de la vitre - Misura del vetro - Glas afmeting - Klaasi mõõt: 390x1602 mm</p> 		 <p data-bbox="1362 439 1497 472">460x1684 mm</p>		



Pos

29.11.2017 Piece list - Stückliste - Liste des pièces - Elementi - Stuklijst - Tükítabel  
1010x1780 TAK.1.100.TPM0.e DGP+ 9/9

Q

P  
(mm)

L  
(mm)

Glass size - Glasgröße - Taille de la vitre - Misura del vetro - Glas afmeting - Klaasi mõõt: 390x1602 mm

